



Washington  
State Department of  
Agriculture

In 2015, the Washington State Department of Agriculture (WSDA) entered into an Interlocal Agreement with Yakima County to study nitrogen sources within the Lower Yakima Valley Ground Water Management Area (GWMA).

Attached you will find the draft report of the study which was produced jointly by the Washington State Department of Agriculture, Natural Resources Assessment Section and Yakima County Public Works Department. This draft is presented to the Ground Water Advisory Committee Work Groups for review and comment. Comments will be evaluated and incorporated for inclusion into future drafts of this report.

Under the provisions of the Interlocal Agreement, this study is limited in scope in several respects. It presents modeled estimates of nitrogen availability throughout the GWMA, but did not calculate how much is actually transported to groundwater. Estimations of nitrogen transport to groundwater would require further analysis and would need to take into account attenuation processes in the soil and vadose zone.

The analyses performed do not reflect site specific conditions, rather they are intended to reflect calculations of potentially available nitrogen within the overall study area. And further, does not reflect individual decisions or management practices. The high, medium, and low nitrogen availability estimates are not intended to capture conditions in any specific portion of the study area. They are intended to provide insight into what sources would likely need additional focus and study to support any future fate and transport analyses or future management decisions.

This draft report has been reviewed by relevant experts for each report section. Peer review by staff of Washington State Departments of Ecology and Health included repeated cycles of draft review, meeting, and editing to reflect peer reviewer's comments. Inputs for the different analyses were reviewed by the relevant working groups (RCIM, Irrigated Agriculture, and CAFO). Finally, the irrigated agriculture analysis was reviewed by faculty in WSU's Department of Crop and Soil Sciences and by the Irrigated Agriculture Working Group.

We have given our best efforts to conduct this study within the parameters established for this project. We look forward to further review and input from the various work groups as we move forward. Questions relating to any aspects of the study should be directed to WSDA's Natural Resource Assessment Section.

DRAFT

*This page intentionally left blank*



Washington  
State Department of  
Agriculture

## **Estimated Nitrogen Available for Transport in the Lower Yakima Valley Groundwater Management Area**

---

**A Study by the  
Washington State Department of Agriculture  
and  
Yakima County**

WSDA authors

Gary Bahr, Perry Beale, Margaret Drennan, Jaclyn Hancock, and Kelly McLain

Yakima County authors

Cynthia Kozma, Michael Martian, Vern Redifer, P.E.

**April 2017**

Publication No. xxx

*Do you need this publication in a different format?*

*Contact the WSDA receptionist at (360) 902-1976 or TTY (800)833-6388*

## **Publication and Contact Information**

**This report is available on the Department of Agriculture's website at**  
[agr.wa.gov/FP/Pubs/NaturalResourcesAssessmentPubs.aspx](http://agr.wa.gov/FP/Pubs/NaturalResourcesAssessmentPubs.aspx)

### **Contact Information**

#### **WSDA**

[Gary Bahr](#)

Natural Resources Assessment Section Manager

Office of the Director

Phone: (360) 902-1936

P.O. Box 42560

Olympia, WA 98504-2560

[Hector Castro](#)

Communications Director

Office of the Director

Phone: (360) 902-1815

P.O. Box 42560

Olympia, WA 98504-2560

#### **Yakima County**

[Vern Redifer, P.E.](#)

Director, Public Services

Yakima County

Phone: (509) 574-2300

128 N 2<sup>nd</sup> Street

Yakima, WA 98901

**Estimated Nitrogen Available for Transport in the  
Lower Yakima Valley Groundwater Management Area**

---

**A Study by the  
Washington State Department of Agriculture  
and  
Yakima County**

WSDA authors

Gary Bahr, Perry Beale, Margaret Drennan, Jaclyn Hancock, and Kelly McLain

Yakima County authors

Cynthia Kozma, Michael Martian, Vern Redifer, P.E.

## Acknowledgements

### Dairy producers:

- voluntarily shared manure testing results with South Yakima Conservation District
- invited WSDA NRAS staff onto their farms to sample soil in pens and compost areas
- invited WSDA NRAS staff onto their farms to learn about operational practices

### Irrigated Agriculture Working Group

- reviewed irrigated agriculture methodology and assumptions
- grower members of the IAWG supplied production information necessary for calculating triticale double-crop production acres
- Jim Trull, Scott Stephens, and SVID compiled crop nitrogen uptake data
- Jim Davenport and Stu Turner compiled water duty data for crops in this report

### CAFO Working Group

- made recommendations on inputs for lagoon calculations

### Peer review team:

- Melanie Redding (Department of Ecology)
- Ginny Stern (Department of Health)
- Nancy Darling (Department of Health)

### WSDA Dairy Nutrient Management Program

- shared data from their lagoon assessment process
- worked closely with NRAS staff to make sure identification of facilities was as accurate as possible
- reviewed this report to make sure dairy operations were accurately described

### South Yakima Conservation District

- collected and anonymized data from dairy producers
- reviewed GIS data for accuracy

### Katie Hurlburt, WSDA Natural Resources Assessment Section

- conducted additional crop mapping and QA on the GIS data for this report

### Joel Demory, WSDA Natural Resources Assessment Section

- conducted QA on data entry and calculations for this report

### Dr. Ranil Dhammapala, Washington State Department of Ecology

- provided information on atmospheric deposition monitoring and recommendations for low, medium, and high potential rates of atmospheric deposition

### Jean Mendoza, Groundwater Advisory Committee member

- provided a reference for nitrogen loss to atmosphere from irrigated agriculture

# Contents

Contents..... iv

List of Figures..... vi

List of Tables..... vii

Executive Summary..... 1

Introduction and study area ..... 5

Methodology and Limitations ..... 8

1. CONCENTRATED ANIMAL FEEDING OPERATIONS..... 9

    Background and literature review ..... 9

        Pens ..... 11

        Lagoons ..... 12

PENS AND COMPOST AREAS ..... 13

Methods, limitations, and assumptions..... 13

    Limitations..... 13

    GIS methodology ..... 15

    Calculation methodology ..... 15

Results and discussion..... 16

LAGOONS..... 20

Methods, limitations, and assumptions..... 20

    Limitations..... 20

    GIS methodology and lagoon identification..... 20

    Lagoon dimensions ..... 21

    Lagoon nitrogen concentration..... 22

    Atmospheric deposition and volatilization in lagoons..... 23

    Lagoon liner permeability and thickness..... 24

    Calculation methodology ..... 25

Results and discussion..... 25

SETTLING PONDS..... 27

Conclusions and recommendations ..... 27

2. IRRIGATED AGRICULTURE..... 29

Background..... 29

Methods, limitations, and assumptions..... 30

    Limitations..... 30

    Data Collection..... 31

    Mass Balance..... 33

    Determination of Inputs, Outputs, and Transformations..... 33

    GIS Compilation ..... 37

Results and discussion..... 37

Conclusions and recommendations ..... 48

3. RESIDENTIAL, COMMERCIAL, AND INDUSTRIAL SOURCES..... 50

Background ..... 50

Residential On-Site Sewage Systems ..... 50

Methods .....50

Nitrogen Loading to a ROSS..... 54

Nitrogen Removal by Denitrification.....54

Nitrogen Removal by Septage Pumping..... 55

ROSS Results ..... 56

Large On-site Septic Systems..... 59

    Background .....59

    LOSS Results..... 59

Commercial On-site Septic Systems..... 60

    Background ..... 60

    COSS Results ..... 60

Residential Lawn Fertilizer ..... 61

    Methods ..... 61

    Residential Fertilizer Use Results ..... 63

Small-Scale Commercial and Hobby Farms ..... 63

    Background ..... 63

    Methods ..... 64

    Small-Scale Commercial and Hobby Farms Results ..... 64

4. ATMOSPHERIC DEPOSITION ..... 66

    Background ..... 66

    Methods, Limitations, and Assumptions..... 67

        Limitations..... 67

        Methods ..... 67

    Results..... 68

    Conclusions and Recommendations ..... 68

Conclusions and Recommendations ..... 70

References ..... 75

Appendix A: Data Sources, Uses, and Potential Concerns..... 79

Appendix B: Lagoon Nitrogen Concentration Statistical Analysis ..... 84

Appendix C: Lagoon Surface Area Reduction Methodology ..... 85

Appendix D: Darcy’s Law Example Calculation..... 88

Appendix E: Sensitivity Analysis on Darcy’s Law..... 89

Appendix F: Irrigation Water Use..... 90

Appendix G: Nitrogen Uptake Estimates..... 91



## List of Figures

Figure 1. Map of Yakima ground water management area .....	5
Figure 2. Nitrogen cycling pathways in agricultural settings.....	7
Figure 3. Livestock in Yakima County since 1925 (USDA NASS, Commerce).....	10
Figure 4. Average nitrate profile beneath 12 pens in the Yakima Valley. Error bars represent one standard deviation from the mean.....	19
Figure 5. Inputs in the irrigated agriculture mass balance .....	40
Figure 6. Irrigation types for all GWMA acreage and top 3 commodities with surplus nitrogen inputs (per acre). Due to rounding, categories with 0% are either 0 or values less than 1 that rounded to 0. ....	41
Figure 7. Map of Yakima GWMA with low range nitrogen availability estimates.....	46
Figure 8. Map of Yakima GWMA with medium range nitrogen availability estimates.....	47
Figure 9. Map of Yakima GWMA with high range nitrogen availability estimates.....	48
Figure 10: Residential on-site sewage systems .....	52
Figure 12. Example of a six mile diameter high value Nitrogen Loading Analysis (tons of N/year) for a random area located near Sunnyside, Washington. ....	70
Figure 13. Low, medium, and high estimates from all sources, with percentage of total for each category .....	72
Figure 14. Boxplots of EPA and SYCD lagoon N concentration data .....	84
Figure 15. Profile view of typical manure storage lagoon construction. Not drawn to scale; the vertical scale on this diagram is exaggerated to show the side slopes and liquid level clearly.....	85
Figure 16. A typical square manure storage lagoon, with side length and surface area shown at both full and reduced capacities .....	86
Figure 17. A typical rectangular manure storage lagoon, showing length, width, and surface area at full and reduced capacities .....	87
Figure 18. Results of sensitivity analysis on Darcy's law.....	89

## List of Tables

Table 1. Estimated nitrogen available for transport from all sources at low, medium, and high range in tons/year and % of total.....	3
Table 2. Estimated nitrogen available for transport per acre from all sources at low, medium, and high range .....	3
Table 3. Dairy lagoon manure sampling results derived from or used by studies in California and the Yakima Valley.....	13
Table 4. Acres of dairy CAFO, nondairy CAFO, and compost in the GWMA, with the percentage each category represents of the total area identified .....	16
Table 5. Potential nitrogen available for transport from dairy and nondairy CAFOs.....	17
Table 6. Soil sampling results beneath 12 pens in the Yakima Valley.....	18
Table 7. Estimated high and low loss rates based on Darcy's law .....	26
Table 8. Top 15 crops and their acreage in the GWMA.....	30
Table 9. Acreage in each commodity, with data collection targets and collection results.....	32
Table 10. Summary statistics for Yakima River nitrogen concentrations (USGS 2012).....	35
Table 11. Summary statistics of organic matter percentage of sampling in the 2015 Yakima Valley deep soil sampling study (n = 108).....	36
Table 12. Summary of fertilizer types used for the top 15 crops by acreage in the GWMA.....	38
Table 13. Ranges of application rates (with weighted average in parentheses) reported for commercial fertilizer, manure, and compost.....	39
Table 14. One year's worth of inputs and outputs for the top 15 crops in the GWMA.....	43
Table 15: Sum of inputs and outputs for the top 15 crops in the GWMA (entire acreage).....	44
Table 16. Maximum hydraulic loading rate.....	51
Table 17. Input parameters for estimating total nitrogen from ROSS.....	56
Table 18. ROSS nitrogen loading estimate .....	57
Table 19. Migrant workforce estimate .....	58
Table 20: Estimated Total Nitrogen Loadings from ROSS Drainfields.....	59
Table 21: Estimated Loading from LOSS systems.....	60
Table 22. GWMA CAFO herd size and employee estimate.....	61
Table 23: Estimated Loading from COSS .....	61
Table 24. Representative lawn areas in the GWMA .....	62
Table 25. Residential lawn areas .....	63
Table 26: Estimated N loading from Residential Fertilizer.....	63
Table 27. Parcel size and total acres.....	64
Table 28. Percent of fertilizer application by hobby farm size.....	64
Table 29. Total nitrogen loading for hobby farms .....	65
Table 30. Low, medium, and high atmospheric deposition rates.....	68
Table 31. Estimated atmospheric nitrogen deposition in the GWMA .....	69
Table 32. Estimated nitrogen available per acre from all sources at low, medium, and high range ..	71
Table 33. Comparison of EPA and SYCD lagoon N concentration (mg N/L).....	84

## Executive Summary

In recent years, a number of groundwater studies have pointed to concerns about nitrate levels in groundwater in the Lower Yakima Valley. Between 1988 and 2008, 12% of wells tested in the area had nitrate concentrations above the Safe Drinking Water Act Maximum Contaminant Level of 10 mg NO<sub>3</sub>-N/L. Another 21% of wells tested were below this level but higher than 5 mg NO<sub>3</sub>-N/L (reported in Ecology et al. 2010).

In response, the Washington State Department of Ecology (Ecology) began working with Yakima County to address the issue and provide solutions to prevent nitrate contamination of groundwater in the Lower Yakima Valley. They established the Lower Yakima Valley Groundwater Management Area (GWMA), and in 2011 the Groundwater Advisory Committee (GWAC) was formed.

- The GWMA includes the land area and groundwater located in the lower Yakima Valley from Union Gap to County Line Road in Yakima County, Washington, minus the Yakama Nation. The majority of the GWMA is used for agriculture, including about 99,000 acres of irrigated crop land and more than 50 active dairy farms (WSDA 2016). The remainder of the GWMA land area consists of towns, rural residences, roads, canals, and other nonagricultural lands.
- The GWAC has worked to assess and respond to the groundwater nitrate issues by addressing public education and health concerns, evaluating existing data on groundwater quality, designing new monitoring strategies, evaluating regulatory responsibilities, and determining potential nitrogen availability from the various potential sources.

As partners, Ecology, the U.S. Environmental Protection Agency, Yakima County, the Washington State Department of Agriculture (WSDA), and the Washington State Department of Health have been working to support the GWAC and associated workgroups with educational and scientific products that can assist in decision making to protect groundwater quality.

### About the Study

In 2015, the Yakima County Public Services Department and GWAC partnered with WSDA to conduct a study to provide a scientific baseline estimate of the amount of potential nitrogen available for transport from different nitrogen sources within the GWMA boundaries. Nitrogen available for transport is nitrogen that has the potential to move from the land surface or soil profile into groundwater. The study addressed how much nitrogen could be available, but did not calculate how much is actually transported to groundwater. The processes controlling nitrogen movement through the soil were not evaluated, and loading to groundwater was not estimated.

Nitrogen sources are numerous and can include agricultural, human, natural soil organic matter, and atmospheric deposition. Together, state and local partners studied estimated potential nitrogen availability in the landscape from 4 distinct categories:

- Concentrated Animal Feeding Operations (CAFOs) - including livestock pens and manure lagoons;
- Irrigated agricultural activities - including nitrogen balance from the 15 types of irrigated crops that constitute 96% of the irrigated acreage in the GWMA;

- Residential, commercial, industrial, and municipal (RCIM) sources - including residential onsite septic systems (ROSS), large onsite septic systems (LOSS), commercial onsite septic systems (COSS), residential lawn fertilizers, and hobby and small-scale commercial farms;
- Atmospheric sources - including wet and dry deposition.

Nitrogen estimates were calculated for the land surface, bottom of the root zone, and at the extent of the treatment zone for animal agriculture, irrigated agriculture, RCIM, and atmospheric sources.

The estimates were completed using locally-derived information wherever possible, and information gaps were filled with data from scientific literature. Methodologies varied, depending on the source of nitrogen being studied. For example, some calculations used data gathered from aerial imagery. Some calculations compared inputs and outputs to determine the mass balance of nitrogen from various irrigated agriculture sources. Atmospheric calculations included adjustments to avoid double counting with other categories that already included atmospheric nitrogen. The body of the report addresses the methodologies used for each source studied.

The study was limited by a number of constraints, primarily the limited availability of local background data, the diversity of local or literature data used, and the various assumptions utilized for the calculations in each section of the report. This data used as inputs and the study itself have been reviewed by experts in each field. The data inputs used in each section were reviewed by the relevant GWAC workgroups (Irrigated Agriculture, CAFO, and RCIM). The irrigated agriculture calculations were reviewed by faculty from Washington State University's Department of Crop and Soil Sciences. In addition, the report draft has been reviewed by a peer review team composed of hydrogeologists from the Washington State Departments of Ecology and Health.

### Study Results

The nitrogen available for transport was estimated at 3 levels (low, medium, and high) for each nitrogen source category evaluated in this study. The estimates were then assessed both on a per-acre basis and for the entire GWMA, providing 2 ways to consider the nitrogen sources. WSDA and Yakima County results were summarized in associated data spreadsheets and GIS based systems, allowing them to be updated in the future as additional data becomes available.

When the low, medium, and high nitrogen calculations were analyzed for all sources over the entire acreage of the GWMA (Table 1), irrigated agriculture, CAFO lagoons, and CAFO pens were the most significant contributors to potential nitrogen availability in all 3 scenarios. In the low range scenario, agricultural activities constitute 86% of the estimated total nitrogen available. In the medium and high range scenarios, agricultural activities constitute 95% and 96% of the estimated nitrogen available, respectively. The irrigated agriculture nitrogen percent is the highest in the low, medium and high categories due to the large number of acres of agriculture in the GWMA.

Table 1. Estimated nitrogen available for transport from all sources at low, medium, and high range in tons/year and % of total

Source		Low		Medium		High	
		Tons N/year	%	Tons N/year	%	Tons N/year	%
Irrigated Agriculture		532	62	2,870	66	8,685	76
CAFO	Pens	70	8	502	11	935	8
	Lagoons	142	16	781	18	1,421	12
RCIM	All septic (ROSS, LOSS, COSS)	47	5	83	2	135	1
	Residential fertilizer	10	1	26	1	41	0
	Small scale farms	4	1	11	0	18	0
Atmospheric Deposition		57	7	76	2	227	2

\*All numbers in this table have been rounded to the nearest ton, or the nearest whole number, in the case of percentages. Some low but nonzero percentages have been rounded to zero.

When assessed on a per-acre basis (Table 2), the sources that contribute the most nitrogen differ from those contributing the most nitrogen over the entire GWMA. Nitrogen estimates from irrigated agriculture are the top contributor when assessed over the entire GWMA because of the large number of acres assessed, but are not in the top 3 on a per-acre basis.

Some management units have relatively small acreages, but contribute large amounts of nitrogen per acre. For example, the LOSS estimates at the low range are one of the top 3 contributors of nitrogen on a per-acre basis, but they have an extremely small total acreage in the GWMA (3 acres). The CAFO lagoon and ROSS estimates at the low, medium and high ranges are in the group of the top 3 highest contributors on a per-acre basis (shaded in blue in Table 2). CAFO lagoon and ROSS acreage in the GWMA are relatively small when compared to larger source areas such as irrigated agriculture, atmospheric deposition, and residential fertilizer.

Table 2. Estimated nitrogen available for transport per acre from all sources at low, medium, and high range

Source		Area (acres)	Low (lb/acre-year)	Medium (lb/acre-year)	High (lb/acre-year)
Irrigated Agriculture		96,186	11	60	181
CAFO	Pens	2,096	67	480	892
	Lagoons	210	1,354	7,448	13,542
RCIM	ROSS	398	223	403	662
	LOSS	3	195	209	225
	COSS	30	163	173	183
	Residential Fertilizer	4,381	4.7	11.7	18.6
	Small Scale Farms	2,096	4.3	10.7	17.1
Atmospheric Deposition		73,976	1.53	2.05	6.15

Blue shading indicates top 3 contributors in each range (low, medium, high).

### Looking Ahead

NRAS has identified a number of data needs to add to these estimates. Both WSDA and Ecology are engaged in work that will aggregate information about lagoon conditions that could potentially be used to adjust these estimates. Calculations could be updated as data becomes available from the DNMP lagoon liner assessment ratings and Ecology CAFO permit reporting assessments and requirements. Washington State University research on lagoon seepage is beginning that may also provide relevant information. New field research on lagoon seepage could also be conducted if

necessary to supply the needed data. The irrigated agriculture mass balance estimates could be compared to current and future deep soil sampling results to improve the accuracy of the analysis. An assessment of additional data for each impoundment classification (lagoon, flush/main lagoon, farm/irrigation pond, settling basin) could be used to apply seepage rates and nitrogen concentrations specific to each use. A statistically-based study of soil nitrogen concentrations beneath pens could be conducted to confirm estimates used in this study that were developed in other regions of the country. Additional areas of inquiry are discussed in the Conclusions and Recommendations section.

Even though estimates may be refined in the future, this comprehensive study was successful in making an initial estimate of potentially available nitrogen from different sources throughout the GWMA. Per-acre estimates from each source category can be reviewed spatially to identify areas where risk and vulnerability are potentially high. The use of this spatial component allows for more complex future analysis with the inclusion of other relevant data layers such as soil type, depth to groundwater, groundwater nitrate concentrations, soil sampling results, and proximity to public drinking water systems.

DRAFT

## Introduction and study area

Yakima County is located in central Washington State. This study focuses on the lower Yakima Valley, located in the southeastern portion of the county and bordered by the Rattlesnake Hills to the north, the Yakama Nation to the west, and Benton County to the east. The Yakima Groundwater Management Area (GWMA) is shown in Figure 1, with major cities and roads noted. The current population of Yakima County is just over 240,000 people, and the major metropolitan area is the city of Yakima (Census 2010). The county’s main industry is agriculture, with a 2013 farm gate value of \$1.65 billion (USDA NASS 2014). The major commodities produced are apples, milk, and hay. The lower valley agricultural landscape includes more than 50 active dairy farms and approximately 100,000 acres of irrigated farmland (WSDA 2016). The Yakima River runs through the GWMA, and water for agriculture is collectively managed by 5 different irrigation districts: Roza, Sunnyside, Wapato, Zillah, and Grandview.

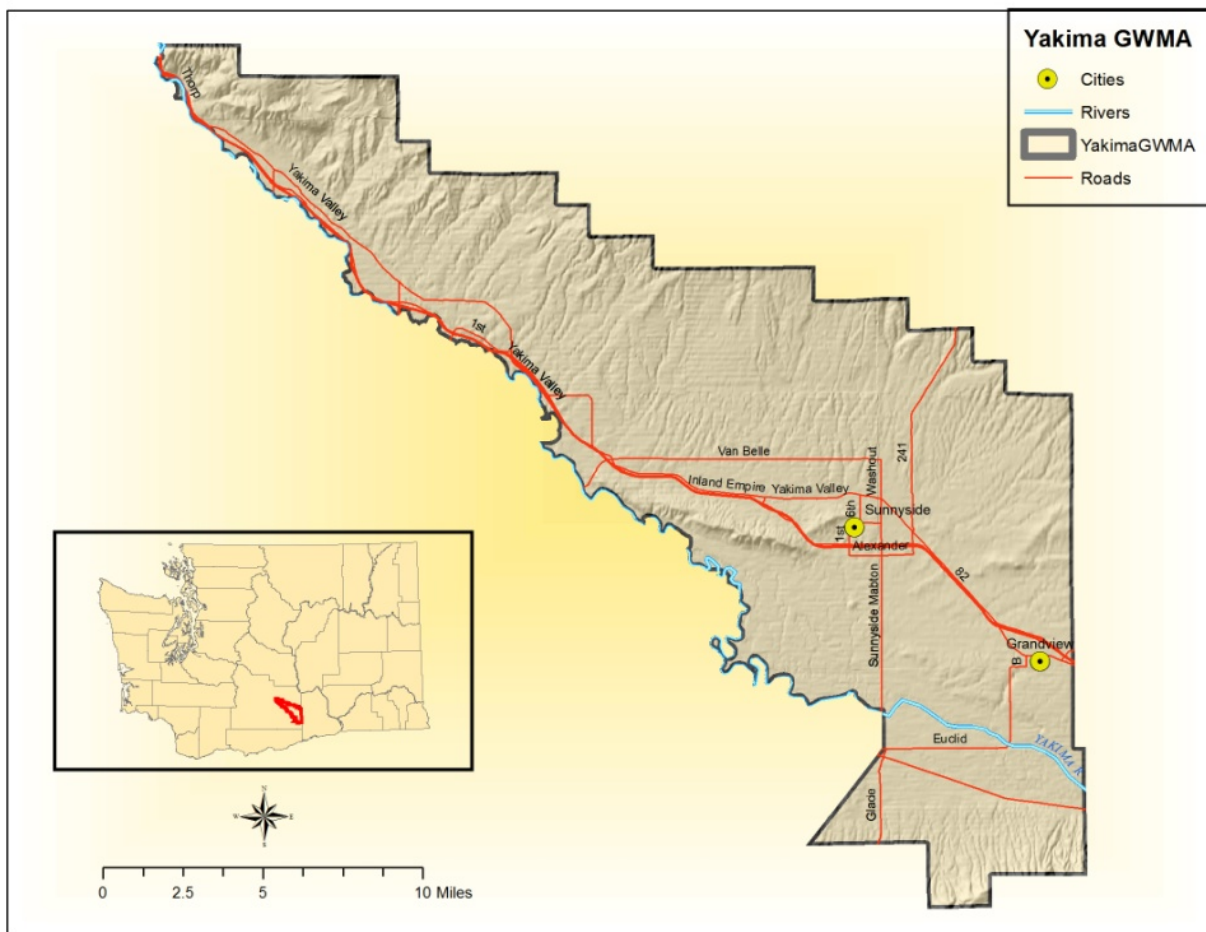

Figure 1. Map of Yakima ground water management area

Within some areas of the GWMA, nitrogen has negatively impacted groundwater quality. The Washington State Department of Ecology (Ecology) summarized results from sampling studies conducted by Ecology, the US Geological Survey, and the Washington State Department of Health

between the early 1990's and June 2008. A total of 1,726 nitrate testing samples from 453 well sites were summarized. Data sources included nitrate test results from 328 domestic wells, 93 public wells, and 33 wells of other types including some used for irrigation. Of wells with nitrate detections, 67% were less than 5 mg NO<sub>3</sub>-N/L, 21% were between 5 and 9.9 mg NO<sub>3</sub>-N/L, and 12% were greater than 10 mg NO<sub>3</sub>-N/L. The Maximum Contaminant Level set by the US Environmental Protection Agency (EPA) for nitrate is 10 mg NO<sub>3</sub>-N/L; concentrations approaching and above this level are of concern due to the potential impact to human health (EPA 2013a, Ecology et al. 2010). Shallower wells (which were more likely to be domestic wells) had more nitrate detections and exceedances than deeper wells (Ecology et al. 2010). An EPA study concluded that agriculture and livestock operations within the GWMA were significant contributors to nitrogen loading to the underlying groundwater (EPA 2013a).

In 2011, Ecology authorized the formation of the lower Yakima GWMA. This group, made up of area residents, representatives from the agricultural industry, and scientists and experts from county, state, and federal government agencies, is focused on identifying potential contaminant sources and preparing a management strategy for the affected area.

EPA conducted a multi-phase study to identify potential nitrate sources and other contaminants. After source identification, EPA conducted groundwater monitoring up- and downgradient from potential sources (including several large dairies) in 2010 (EPA 2013a). As a result of this groundwater sampling, in March 2013, EPA signed an Administrative Order on Consent (Consent Order) with 5 dairies in the lower Yakima Valley (EPA 2013b). The purpose of this consent order was to address sources of nitrate contamination in groundwater near and downgradient of the dairies' facilities. These dairies have begun additional work to control nitrate sources, collect data, and monitor groundwater quality to assess the effectiveness of the source control actions.

This report is the result of a request in 2015 by the GWMA's Ground Water Advisory Committee for the Washington State Department of Agriculture (WSDA) Natural Resources Assessment Section (NRAS) and the Yakima County Public Services Department to complete an estimate of nitrogen loading potential within different land use classes in the lower Yakima Valley. This report outlines estimated nitrogen available for transport from the following land uses: irrigated agriculture, concentrated animal feeding operations (which includes both dairies, dairy support such as heifer raising, and beef cattle feedlots), residential, commercial, industrial, and municipal sources. The land uses were divided into 3 separate sections for calculations: irrigated agriculture, concentrated animal feeding operations (CAFOs), and residential, commercial, industrial, and municipal (RCIM) sources. A separate section estimates the potential contribution to groundwater nitrogen from atmospheric deposition of nitrogen. The data was collected from a variety of sources and through different methods, including phone interviews, on-farm data collection, analysis of aerial imagery, ground surveys for spatial analysis, and local zoning and land use information.

Nitrogen has an extremely complex cycle in the environment, with a number of different pathways for accumulation and removal. Figure 2 shows how these pathways might work in an agricultural system (Fertilizer and Lime Research Centre, 2014).



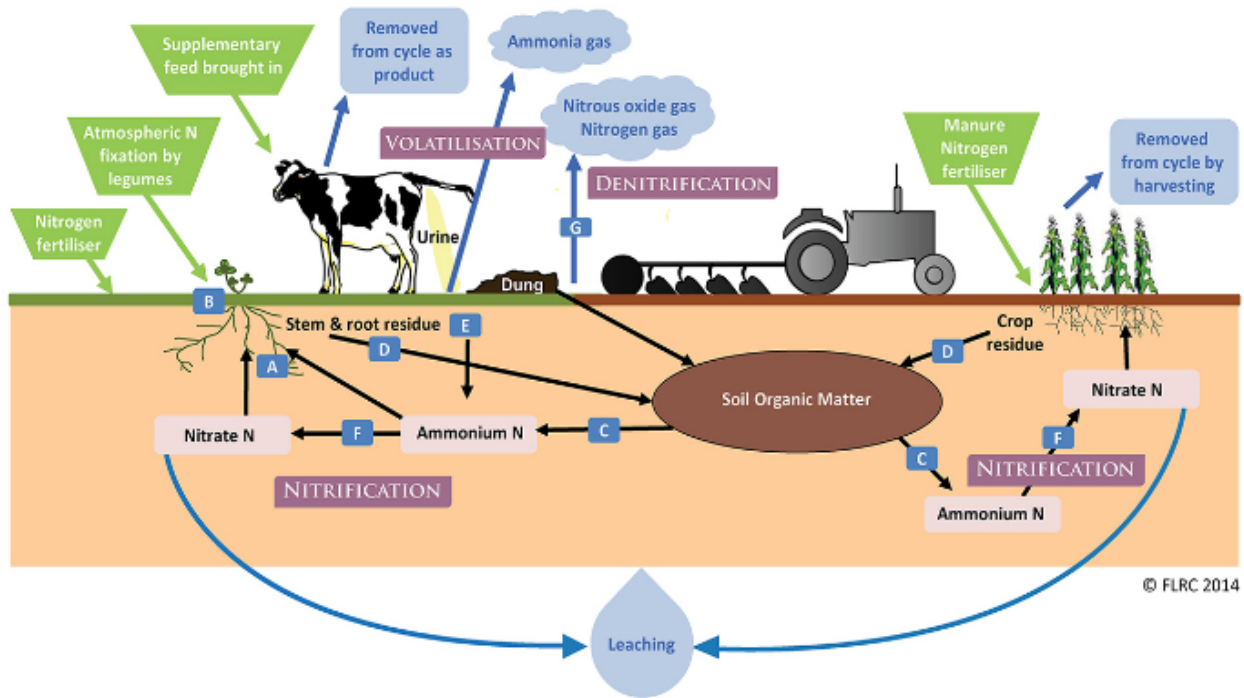

- A. Plant uptake of N; B. N fixation by legumes; C. Decomposition of organic matter to Ammonium;
- D. Plant residues and dung to soil organic pool; E. Enzyme conversion of Urea to Ammonium;
- F. Nitrification - the conversion of Ammonium to Nitrate; G. Denitrification - the conversion of Nitrate to Nitrous Oxide gas and then to Nitrogen gas.

Figure 2. Nitrogen cycling pathways in agricultural settings

This study is the first conducted in the lower valley that uses local information to address the potential pathways for nitrogen loading. It is also the first project completed for the GWMA that pairs estimated nitrogen surpluses with GIS-based land use information. The purpose of this report is to understand available nitrogen from nitrogen sources and enable the GWMA advisory committee to better direct remediation strategies throughout the region.

## Methodology and Limitations

The objective of this report was to provide information to the Groundwater Advisory Committee that can be used to make decisions about how to use limited resources to meet the long-term goals of reducing nitrate concentrations in groundwater until they meet groundwater standards. This report is not intended as a final statement on potential nitrogen contributions from different sources, instead it represents a first step. Recommendations are made for future experimental research to improve estimates, and additional data sets have been identified for future inclusion that are currently available or will become available in the future. These calculations can and should be updated as new information becomes available.

Nitrogen loading potential was assessed differently in each section (irrigated agriculture, CAFO, and RCIM). Fate and transport of the nitrogen through the soil profile to groundwater is not explored in this document. For each operational unit the objective was to determine the total nitrogen available for transport at the end of the 'treatment zone'. This location is different for different sectors,

- for irrigated agriculture it is nitrogen available at the bottom of the root zone, when it becomes unavailable for plant uptake,
- for lagoons it is the bottom of the lagoon liner, when it is available to move through the soil profile under some conditions,
- for pens it is the bottom of the manure-soil interface layer, when it is available to move through the soil profile under some conditions,
- for septic systems it is the end of the drainfield,
- for residential fertilizer use it is the land surface, and
- for small scale commercial and hobby farms it is the land surface.

One challenge for both conducting this study and interpreting and comparing the results in the different sections is the diversity of data sources used for calculations. Data sources included self-reported data from producers, data from peer-reviewed literature, data from state and federal government studies, averaged data, specific local data, general national data, and estimates based on best professional judgment. Examples of just a few of the many data sources used for calculations in this study are:

- fertilizer use practices (self-reported survey information, local and crop specific data),
- analytical results from testing of lagoon nitrogen concentrations (self-reported, testing results from certified labs, sample not statistically selected),
- analytical results from testing of lagoon nitrogen concentrations (local data, EPA sampling and analysis procedures, sample not statistically selected),
- GIS data derived from ground-based mapping, human analysis of aerial imagery, and automated analysis of aerial imagery with ArcMap tools (local data, accuracy may vary depending on analysis method),
- estimates by experts in different specialties (local data, estimates may vary depending on expert judgment), and
- national- and state- level data and estimates for performance of septic systems (larger-scale data may not be accurate for local conditions).

An additional challenge in reviewing data presented in the literature and experimental results is the many units used and species of nitrogen reported in papers. Nitrogen is often reported as nitrate, nitrate-N, organic nitrogen-N, TKN, ammonia/ammonium, ammonia/ammonium-N, combinations of these, or as total nitrogen, which makes comparison of literature results difficult and sometimes impossible

This study relies on a wide variety of data sources, which has to be considered when interpreting and using the results. Not all sources will be considered equally credible according to the Water Quality Data Act (RCW 90.48.570-90.48.590, Water...2004). This can make it difficult to compare data sources and calculation results. In order to allow readers to evaluate data sources on a case-by-case basis each data source used, the calculation it was used for, the source, and potential concerns with the data source have been collected in a table (Appendix A: Data Sources, Uses, and Potential Concerns). Wherever possible, summary statistics have been presented and a careful choice has been made for what value (mean, median, or an alternative) to use in calculations.

The conclusions section of this report makes suggestions for critical additional research to refine these estimates through additional data collection. The spatial component of this data is extremely important. Wherever possible, nitrogen availability has been presented both as an aggregate over the entire GWMA and on a per-acre basis. This per-acre nitrogen availability can be spatially associated with sources to examine nitrogen availability at different scales and in different regions.

## 1. CONCENTRATED ANIMAL FEEDING OPERATIONS

WSDA authors: Margaret Drennan, Jaclyn Hancock, Gary Bahr

### Background and literature review

Over the past 90 years, the number of cattle and dairy farms has been decreasing. The number of cattle and calves has increased relatively steadily during that time. The number of dairy cows was relatively stable between 1925 and 1969, but after 1969 the number of dairy cows began to increase steadily, which has continued until 2012. Between 1969 and 2012 USDA's estimate of dairy operations went from 7,868 cows on 301 farms to 99,532 milk cows on 97 farms (USDA NASS 2014). Dairy farms are increasing in size while the number of farms is decreasing. As of 2012, USDA also notes the presence of relatively low numbers of other livestock: hogs and pigs, sheep, goats, horses, and poultry (USDA NASS 2014). This USDA statistical data is available only at the county level.

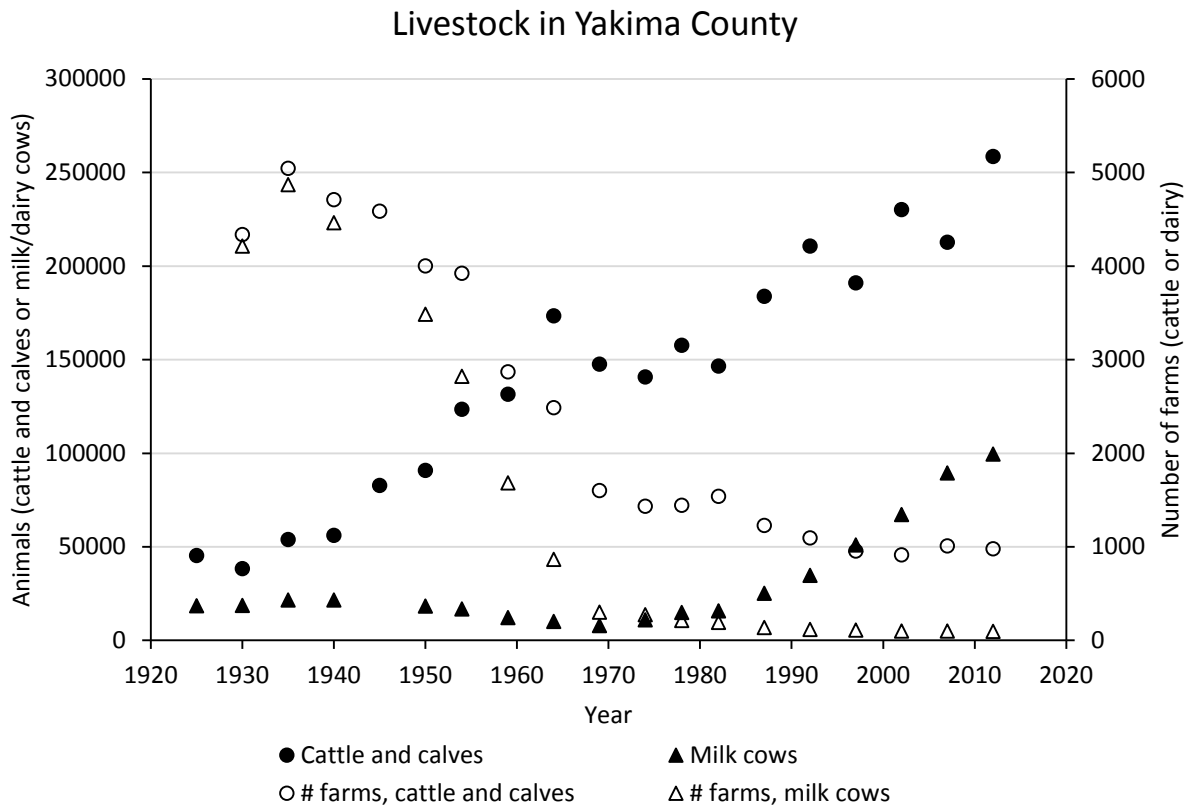

Figure 3. Livestock (cattle and dairy cows) in Yakima County since 1925<sup>1</sup>

Dairies are the only Washington State livestock operations whose manure management is inspected and regulated by WSDA, in accordance with Washington’s Dairy Nutrient Management Act (Dairy...1998). Dairies are required to register with WSDA’s Dairy Nutrient Management Program, develop nutrient management plans, maintain records of manure applications, and are inspected regularly by DNMP staff. As a result, dairies are the facilities about which most information is available. Dairy support animals (dry cows, calves, and heifers) are sometimes kept in adjacent facilities and sometimes (in the case of calf and heifer raising operations) moved offsite until maturity.

Whether nitrogen or other contaminants move from operational units to surface or ground water depends on dairy age, management practices, meteorological conditions, soil types, geological conditions, unsaturated zone thickness, and groundwater characteristics. Several studies have attempted to quantify nitrogen loading from entire farms and identify which sector (pens, lagoons, or irrigated fields) makes the largest contribution. Two studies in California used monitoring wells up- and downgradient from different management units in an attempt to measure nitrogen additions from each management unit (Harter et al. 2002, van der Schans et al. 2009). Harter

<sup>1</sup> (Commerce 1927, Commerce 1932, Commerce 1936, Commerce 1942, Commerce 1946, Commerce 1952, Commerce 1956, Commerce 1961, Commerce 1967, Commerce 1972, Commerce 1977, Commerce 1981, Commerce 1984, Commerce 1989, Commerce 1994, USDA NASS 1999, USDA NASS 2004, USDA NASS 2009, USDA NASS 2014)

monitored groundwater at 5 dairies for 4 years and found that it was very difficult to exclude effects from neighboring management units, they concluded that the largest nitrogen contributor on dairies was manure-treated cropland. Total contributions from cropland were much larger than pens or lagoons largely because the acreage of cropland was much larger and made it difficult to distinguish contributions from pens and lagoons (Harter et al. 2002). Another study in California used monitoring wells to calibrate groundwater models specific to 2 dairy farms in California. The study identified nitrate-N losses of 486 kg/ha-yr from manure-treated fields, 872 kg/ha-yr from pens, and 807 kg/ha-yr from lagoons (van der Schans et al. 2009). Another study conducted by a University of California at Davis (UC Davis) team assessed nitrate loading to ground water in prominent agricultural and dairy production areas within the Tulare Lake Basin and Salinas Valley of California. The UC Davis study estimated loading from pens at 75-1,000 kg N/ha-yr. Based on a variety of estimates of seepage rates from manure lagoons and lagoon nitrogen concentrations the UC Davis study estimated nitrogen loading from lagoons at 200-2,000 Mg/year for the entire study area. With a total lagoon area of 1,265 ha this results in a loading rate of 158-1581 kg N/ha-yr (Viers et al. 2012).

### *Pens*

Dairies contain a variety of different operational units dedicated to animal housing, manure management and storage, and sometimes also crop production. Animal holding areas can include concrete-surfaced freestall barns, as well as holding areas which are generally constructed with compacted earth surfaces. These are referred to by a variety of names in different studies but will be referred to in this report as pens. Pens at facilities housing support animals have been classified as 'nondairy CAFO' pens while pens at facilities housing milking cows have been classified as 'dairy CAFO' pens.

The combination of weight and compaction due to the presence of cattle with the physical and chemical changes to underlying soil due to the mixing of soil and manure have been observed to form an interface layer under the deposited manure that allows very little infiltration of liquid to the underlying soil (Mielke et al. 1974). At one feedlot site, researchers were not able to record any infiltration during a 20-day period (Mielke et al. 1974). A study of 3 feedlots in Alberta, Canada confirmed that this interface layer formed within 2 months of cattle stocking. In addition, experimentally-determined permeabilities were similar for coarse- and fine-textured soils. However, despite this interface layer and expected low leaching potential, chloride leaching was detected at all 3 feedlots (Miller et al. 2008). Similarly, at feedlots in Kansas, despite apparently limited infiltration, soil testing beneath pens found elevated concentrations of ammonium, organic nitrogen, nitrate, chloride, and phosphorus. This study compared a mass balance approach to estimate nitrogen leaching from feedlots to subsurface soil testing results. Although elevated concentrations of contaminants were detected, movement of contaminants through the feedlot surface was much lower than what was expected from the mass balance calculation and concentrations were consistent with diffusion through the interface layer (Vaillant et al. 2009). Seepage rates through feedlot surfaces documented in other studies ranged from 0.005 to 2.4 mm/day (reported in Vaillant et al. 2009). The effectiveness of this manure-soil interface layer is dependent on maintenance and surface conditions. Dry conditions combined with animal hoof action or on-farm practices such as pen scraping can damage the aggregated structures,

compromising the interface layer and allowing infiltration or altering subsurface conditions to favor nitrogen transformations and subsequent leaching (Mielke et al. 1974, Vaillant et al. 2009).

The UC Davis report identified 2 large beef cattle feedlots in the Tulare Lake Basin, with stocking rates of 125 and 300 animals/acre. The dairies studied in the Tulare Lake Basin had stocking rates of 50 animals/acre, which does not include support animals (Viers et al. 2012). As of the 2014 DNMP dairy registration, dairies in Yakima County had just over 100,000 milking and dry cows (the vast majority of which were located within the GWMA boundary), making for a stocking rate of around 50 cattle/acre, based on the NRAS estimate of pen acreage, similar to that of dairies in the UC Davis study.

The UC Davis study assessed these studies and local soil testing data (unpublished) to choose low and high nitrogen loading rates for pens. The authors chose 75 kg N/ha-yr as the low loading rate, based on a locally-observed recharge rate below corrals of 50 mm/year and soil moisture nitrate concentrations of 675 mg/L (unpublished data). Citing recharge rates as high as 300 mm/year reported in other studies the UC Davis study used 1,000 kg N/ha-yr as an upper limit for nitrogen loading from pens. However, the authors of that study suggest that the upper bound is an overestimate, potentially as much as an entire order of magnitude too high (Viers et al. 2012).

### *Lagoons*

Depending on the dairy's management practices, manure and urine deposited in freestall barns and pens is transported to storage areas which may be liquid storage impoundments (generally through underground piping and pumping systems) or solids storage and composting areas where solids are dried, stacked, and sometimes composted for further use.

Liquid storage impoundments themselves serve a variety of on-farm uses. Lagoons can provide storage for manure and urine cleaned from barns, but may also capture runoff from roofs and other surfaces and process water from the milking parlor. In addition, lagoon liquid may be recirculated to clean barns with flush systems. Distinguishing between an impoundment primarily used for manure storage and one primarily used for irrigation water storage can be difficult. Contents are transferred between impoundments as needed to meet cleaning, storage capacity, and maintenance needs. The term lagoons is used here to refer to impoundments whose primary purpose is manure storage. In addition to lagoons, some dairies also have dedicated impoundments used for separating solids and liquids. The technical sophistication of these impoundments could range from a pond with a weeping wall to an engineered concrete basin with baffles directing and slowing flow to promote settling.

There is substantial variation both in the composition of solids, liquids, and dissolved constituents, and in seepage rates from lagoons, resulting in wide variation in the potential to impact ground water quality (Ham 2002; Harter et al. 2014). A study of 20 lagoons (14 swine, 5 feedlot, and 1 dairy) found seepage rates between 0.2 and 2.4 mm/day, with an average of 1.1 mm/day (Ham 2002). Groundwater monitoring up- and downgradient from lagoons confirms that contaminants leaching from lagoons contribute to shallow groundwater contamination (Harter et al. 2002, van der Schans et al. 2009, Viers et al. 2012). In one study, testing detected elevated concentrations of TKN (total Kjeldahl nitrogen, a measure of organic N and ammonium/ammonia N combined)

outside the edges of 3 dairy lagoons, and the authors estimated a leaching rate of approximately 1 m/year (Harter et al. 2002).

Nitrogen concentration within lagoons has been tested in a number of studies, and is extremely variable. The UC Davis study conducted extensive literature review and modeling of lagoons and the authors used nitrogen concentrations of 500 and 1,000 mg N/L in their estimates (Viers et al. 2012). A survey of lagoon contents in California sampled more than 60 dairies in California's San Joaquin Valley in 1999 and 2000 and found lagoon TKN concentrations of 47-2,420 mg N/L, with an average of 560 mg N/L (Campbell Mathews et al. 2001). A University of California Cooperative Extension publication reports lagoon nitrogen concentrations from other research on California dairies: one study of 11 dairies found median lagoon total N concentrations ranging from 164-645 mg N/L and another study of 8 dairies found mean TKN in lagoons of 670 mg N/L (Pettygrove et al. 2010). Sampling at 5 Yakima Valley dairies by EPA found total nitrogen concentrations ranging from 290 to 1,800 mg N/L with an average of 1,212 mg N/L (EPA 2013a). These results are summarized in Table 3.

Table 3. Dairy lagoon manure sampling results derived from or used by studies in California and the Yakima Valley

Citation	Project Location	Actual or estimated nitrogen concentration (mg N/L)
EPA 2013a	Yakima Valley, 5 dairies	range 290 - 1,800 average 1,212
Viers et al. 2012	Tulare Lake Basin and Salinas Valley, California	500 1,000
Campbell Mathews et al. 2011	San Joaquin Valley, California	range 47-2,420* average 560*
Pettygrove et al. 2010 (reporting 2 studies)	California	165 – 645 670*

\*TKN is a measure of organic N + ammonia N. In lagoons nitrate is very low or undetectable and TKN is comparable to total N.

## PENS AND COMPOST AREAS

### Methods, limitations, and assumptions

#### Limitations

Every effort has been made in this report to identify facilities and facility uses that are current as of 2015. Staff with WSDA's Dairy Nutrient Management Program (DNMP) worked closely with NRAS to correctly identify facilities and unit operations. However, facilities close and open, and the use of individual unit operations changes. As a result some dairies are included in this analysis that have since closed. Individual pens have been associated with either dairy or nondairy CAFOs. The majority of pens that have been identified as nondairy CAFOs are likely dedicated to raising or housing dairy support animals (calves and heifers). However, individual pens may hold calves during one time period and after those animals are moved out, heifers or adult cows may be moved into that same corral or pen. NRAS has attempted to capture primary uses of different pens but use practices are subject to variation. A small number of the pens identified as nondairy CAFOs are associated with 2 beef cattle feedlots. The calculation used for pens identified as dairy and nondairy

CAFOs is the same, both are based on the methods used by the UC Davis study team (Viers et al. 2012). The same rate was used for both dairy and nondairy CAFOs despite the fact that beef cattle feedlots, dairies, and heifer raising facilities have different characteristics and management practices that would be likely to affect nitrogen loss. Stocking rates, manure volume, manure nitrogen content, animal size, and feed choices would be likely to differ between dairy and nondairy CAFOs, all of which would affect the nitrogen loss at these facilities. NRAS did not have the amount of facility-specific on-site information that would be needed to generate different rates for dairy and nondairy CAFOs. Dividing pens into dairy and nondairy categories would allow different calculations to be conducted in the future if more facility-specific information becomes available. This analysis also does not account for any contribution from cattle kept anywhere other than CAFO pens, such as rangeland or pasture. An estimate of nitrogen available for transport from pasture land is included in Section 2. IRRIGATED AGRICULTURE.

Manure composting areas were identified and the acreage was calculated as part of this analysis. Differences between composting areas and pens include surface construction, the lack of animal movement compacting surfaces, and the difference in moisture inputs between composting areas and pens. Due to these differences, as well as the diversity of potential compost management practices, NRAS did not feel use of the dairy/nondairy CAFO pen rate was appropriate for compost areas. The diversity of composting practices could include composting in windrows, composting in bags, spreading material out over a large surface to dry, turning frequency, moisture additions to maintain optimal composting conditions, or the use of a concrete pad for composting. With no information available in scientific literature about potential loading from compost areas, NRAS did not attempt a calculation for these areas. With the locations and dimensions of composting areas already identified, nitrogen loss from compost areas could easily be calculated in the future if new information becomes available.

Potential nitrogen loss from buildings housing animals was not assessed. Animals may spend time in freestall barns and milking parlors. These facilities are built with concrete floors and cleaned multiple times a day. Although poorly maintained or old concrete may develop cracks that could provide a pathway for contaminants to reach the soil profile, any potential losses from these types of buildings would be orders of magnitude smaller than potential losses from pens and lagoons. Additionally, material removed from these facilities is sometimes transported to lagoons onsite; making the analysis of what nitrogen originated at which unit operation challenging.

Calculating storage in corral subsurface soil was beyond the scope of this report. An accurate calculation would require historic information about dairy and beef cattle numbers and management practices. However, other research demonstrates that soil beneath corrals may hold large amounts of nitrogen that could be released when these facilities are turned to other uses and demonstrates the importance of appropriate decommissioning procedures (Vaillant et al. 2009, Viers et al. 2012).

Potential emissions of nitrogen compounds to the atmosphere from pens and corrals have not been estimated in this report. It is unknown what proportion of emissions from GWMA CAFOs may redeposit within the GWMA, as emissions may travel large distances before eventual deposition (Viers et al. 2012). The rates used for the pen calculations are based on leaching rates and soil and



groundwater testing results from other studies. The influence of atmospheric nitrogen deposition would be accounted for in those testing results already; any atmospheric nitrogen deposited on pen surfaces and lost to soil or groundwater would contribute to nitrogen detected when soil and groundwater are tested. As a result, the pen acreage was removed from the atmospheric deposition summary calculation conducted in the atmospheric deposition section (4. ATMOSPHERIC DEPOSITION).

#### *GIS methodology*

The results of this study were summarized using geographic information systems (GIS). A spatial database called a file geodatabase contains all the GIS data for the livestock section of this study. This database contains both attributes and spatial locations of this data. It contains five feature classes and one table: YakimaGWMA (polygon, GWMA boundary), WSDACrop\_2015 (polygons, crop identification), Lagoons (points), Ponds (points), and CAFO\_Pen\_Compost (polygons, boundaries of pens and compost areas). This database also contains a table, IrrigatedMassBalance, which contained the mass balance calculations and results.

Pen and compost area boundaries represent the locations of dairy and nondairy CAFO unit operations including corrals, feedlots, holding pens, and manure composting areas. These are displayed as polygons in the geodatabase and attributes include the category (dairy CAFO, nondairy CAFO, or compost), area in acres, and low, medium, and high potential nitrogen loss (if calculated). Polygons were drawn by WSDA staff using published 2014 dairy registration locations as a reference along with 2013 National Agricultural Imagery Program (NAIP) imagery from USDA. Dairy and nondairy CAFO pens were distinguished based on information from WSDA's Animal Services Division, facility size, and proximity to a known dairy location, which was based on records from WSDA's DNMP. DNMP staff were consulted to assure accuracy of both location and type of operation. Any roofed area likely to be a freestall barn or milking parlor was excluded.

Quality assurance was performed from November 2015 through February 2016 on all components of the geodatabase. This was a 3-step process. First, a random sampling of each dataset was performed using Excel's random number function and a field survey was conducted of the selected polygons and points in conjunction with USDA NAIP 2013 imagery to ensure the accuracy and location of the data. For the pen and compost boundaries, it was to ensure the operation was a CAFO or compost facility. The last step was to double-check all polygons and points with USDA NAIP 2015 imagery that became available in early 2016, which resulted in several updates due to changes in facility status. All geospatial data used in this study met WSDA data quality error rate of less than 10% (Beale and Baker 2009).

Metadata is included with the GIS database to further describe the additional aspects of the GIS data. This includes information such as the extent, credits, use limitations, scale, processing environment, author, and spatial reference.

#### *Calculation methodology*

The pen nitrogen calculation was based on the low and high loading range used in the UC Davis nitrogen loading study (Viers et al. 2012). The loading rates used in the UC Davis study were chosen based on several other research studies. The low range (75 kg N/ha-yr, or 67 lb N/ac-yr) was

chosen based on unpublished research conducted by UC Davis study authors in the Tulare Lake Basin that was reported in the UC Davis study (Viers et al. 2012). Meteorological conditions in the GWMA are similar to the Tulare Lake Basin, with 7.55 inches of rain each year, on average, in Tulare, CA, and 6.8 in Sunnyside, WA (mean 1894-2012, WRCC 2012, Viers et al. 2012). The high range used in the UC Davis study (1,000 kg N/ha-yr, or 892 lb N/ac-yr) was based on research conducted in the Tulare Lake Basin and Salinas Valley by the study authors, as well as research in California's San Joaquin Valley (van der Schans et al. 2009) and in Kansas (Vaillant et al. 2009). Meteorological conditions in Kansas are significantly different from conditions in either the Tulare Lake Basin or the Yakima Valley (annual rainfall ranged from 24 to 36 inches at the study sites) (Vaillant et al. 2009). However, due to the lack of a large body of similar research to compare results with, there limited data to choose from. The high rate is likely a significant overestimation of the available nitrogen, due to factors that include lower precipitation and higher evapotranspiration in the Yakima Valley than in the regions where the research this nitrogen loading rate was based on was conducted. The lower precipitation and higher evapotranspiration would result in both lower groundwater recharge and higher losses of nitrogen to the atmosphere, reducing the nitrogen available to move through the pen surface.

The calculation itself consisted of multiplying either the low or the high rate by the acreage of each pen. The medium rate for pens was determined by averaging the results of the low and high rates for each individual pen; it has no physical significance. Individual pen results were added to determine estimated losses for all pens in the region.

$$N \text{ loading rate } \left( \frac{\text{lb N}}{\text{acre} \cdot \text{year}} \right) \times \text{Pen acreage (acre)} = \text{Potential N loading } \left( \frac{\text{lb N}}{\text{year}} \right)$$

## Results and discussion

The total area of pens and compost areas is summarized in Table 4. Areas were categorized as either dairy CAFO (pens associated with a dairy operation), nondairy CAFO (pens believed to be associated with either a beef cattle feedlot or dairy support, housing calves or heifers), or compost (areas at either dairy or nondairy facilities where composting is taking place). The total acres of dairy CAFO pens are the largest subset of the pens identified, making up 60.7% of the total 2,632 acres identified as pens or composting areas. The areas of nondairy CAFO pens and compost are similar; those facilities make up 18.9 and 20.4% of the total, respectively.

Table 4. Acres of dairy CAFO, nondairy CAFO, and compost in the GWMA, with the percentage each category represents of the total area identified

	<b>Acres</b>	<b>%</b>
<b>Dairy CAFO pens</b>	1,597	60.7
<b>Nondairy CAFO pens</b>	499	18.9
<b>Compost</b>	536	20.4
<b>Total (pens and compost)</b>	2,632	100

Based on the low and high rates discussed in the calculation methodology and the acreage of different facilities in Table 4, the following potential nitrogen losses were determined (Table 5).

Results were rounded to the nearest ton/yr or 1,000 kg/yr, to be consistent with the estimated accuracy of these calculations. Available nitrogen was calculated for the 2,096 acres of dairy CAFO and nondairy CAFO areas only, as discussed in the Limitations section above. No calculation was conducted for compost areas.

Table 5. Potential nitrogen available for transport from dairy and nondairy CAFOs

	<b>lb N/ac-yr</b>	<b>kg N/ha-yr</b>	<b>Ton N/yr</b>	<b>kg N/yr</b>
<b>Low rate (Viers et al. 2012)</b>	67	75	70	64,000
<b>Medium rate (average)</b>	480	538	502	456,000
<b>High rate (Viers et al. 2012)</b>	892	1000	935	848,000

The high rate is an entire order of magnitude above the low rate. With the information currently available, WSDA is not able to narrow this range.

Management practices onsite such as maintaining an intact interface layer to inhibit liquid movement through the pen surface, changes in precipitation and evapotranspiration from season to season, and animal stocking rates will all affect potential loading.

The 2 large feedlots in the Yakima Valley have a combined acreage of 291 acres. Because only dairies are required to share animal numbers with WSDA, the numbers of animals on these feedlots is unknown. The total number of cattle and calves in Yakima County is 258,663 as of the 2012 Census of Agriculture by USDA NASS. Also from the 2012 Census of Agriculture, the total number of dairy cows in Yakima County is 99,532, which would include only milking and dry cows, not other dairy support animals (calves and heifers) (USDA NASS 2012). The difference (159,131 animals) would include beef cattle on feedlots, cattle and calves on range, and dairy support animals (for example, calves and heifers at dedicated facilities). Of these animals, cattle on feedlots and dairy support animals are accounted for in the calculations, while cattle on rangeland or pasture are not. The census information is for the entire county rather than specific to the GWMA region, but it is likely that the majority of these animals are within the GWMA boundary.

In July 2015, NRAS conducted a soil sampling survey in pens and compost areas at 5 dairies within the GWMA. This data is used here to compare conditions observed beneath pens in the GWMA to conditions observed beneath pens in the Tulare Lake Basin and Salinas Valley, where the loading rates used in the UC Davis study were derived. Similar soil testing results would suggest that the loading rates used in the UC Davis study are appropriate for the GWMA.

Producers who participated in this study allowed NRAS staff onto their property, dig large pits to sample at depths up to 6 feet, and sample multiple locations on the property. Project quality assurance documentation (such as standard operating procedures or a quality assurance project plan) was not developed before sampling, and as a result this data is not considered credible under the requirements of Washington's Water Quality Data Act (RCW 90.48.570-90.48.590, Water...2004). This data should not be used for decision making and it was not used to develop the nitrogen loss rates used in this report. WSDA believes that there are 2 main potential sources of bias or error in this data set. The first is the lack of a statistically-based sampling procedure, meaning that the results may not be useful for assessing the subsurface nutrient concentrations at all the dairies in the GWMA, just at the dairies that were sampled. The second is the potential for

sample cross-contamination due to sample transfer on equipment, meaning that making conclusions based on individual sample results is not recommended. Samples were analyzed at an accredited lab (Northwest Agricultural Consultants, Kennewick, WA). WSDA has used these results (in the aggregate) to gain a better understanding of nitrogen movement and retention in the soil underlying dairy pens and composting areas in the region. These data were compared to subsurface conditions reported in the literature that potential nitrogen loading rates were drawn from. The soil testing results were not used to identify specific rates to use, however, similarities between soil testing results from GWMA dairies and literature results give us more confidence that these rates are appropriate for this study.

Pen samples were collected from 12 locations at depths of 0 (surface) to 6 feet in 1-foot intervals. The table below displays the range in nitrate concentrations found in pens at each 1-foot depth interval (Table 6). Nitrate concentrations from different samples at the same depth were extremely variable. The average concentration decreased throughout the soil profile from 273.3 mg NO<sub>3</sub>-N/kg at the surface to 30.4 mg NO<sub>3</sub>-N/kg at a depth of 6 feet. The average nitrate concentrations by depth were also plotted in a nitrate profile in Figure 4.

Table 6. Soil sampling results beneath 12 pens in the Yakima Valley

Depth in pen (ft)	0	1	2	3	4	5	6
<b>Minimum (mg/kg NO<sub>3</sub>-N)</b>	22.6	21.8	10.6	8.3	6.1	6.5	3.8
<b>Maximum (mg/kg NO<sub>3</sub>-N)</b>	962.6	409.7	199.2	186.5	109.6	93.4	124.7
<b>Average (mg/kg NO<sub>3</sub>-N)</b>	273.3	165.9	98.5	71.2	45.7	36.7	30.4
<b>Median (mg/kg NO<sub>3</sub>-N)</b>	118.6	153.8	89.9	63.6	38	29.6	17.1
<b>Standard dev. (mg/kg NO<sub>3</sub>-N)</b>	308.6	115.3	54.5	45.9	31.1	26.4	36.8

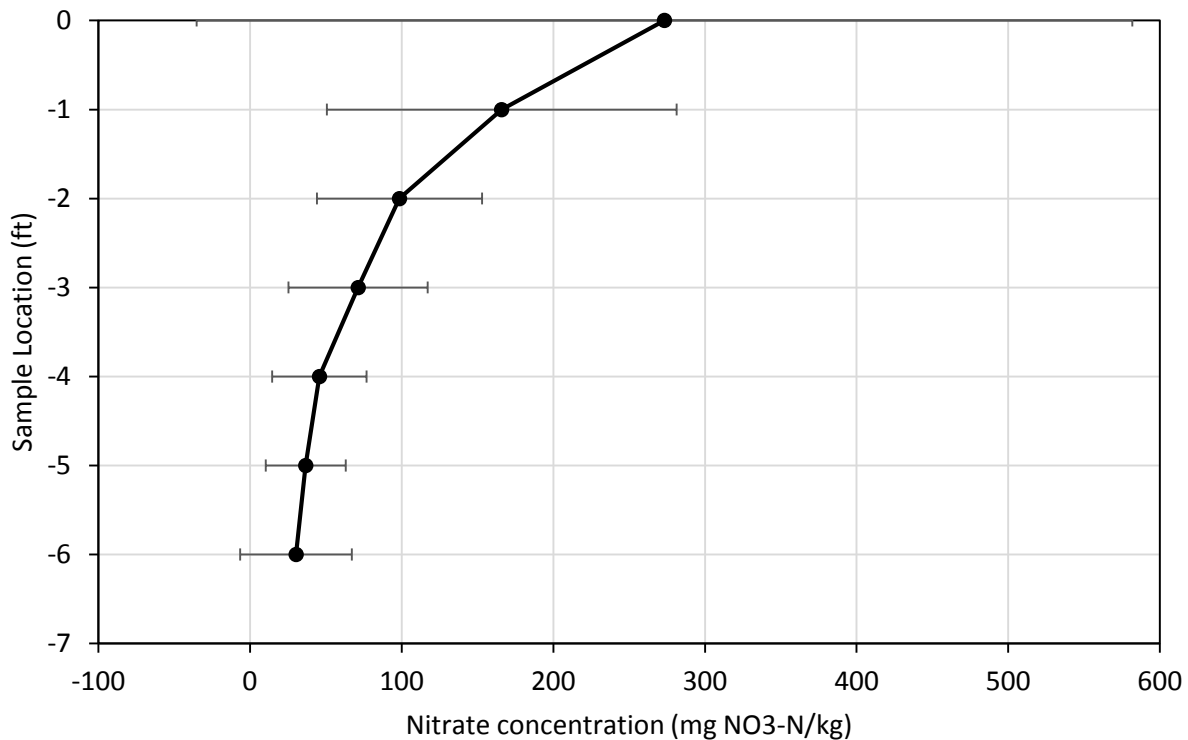

Figure 4. Average nitrate profile beneath 12 pens in the Yakima Valley. Error bars represent one standard deviation from the mean.

Pen soil samples were elevated at the surface and decreased with increasing depth. Soil sampling results are generally compared to a reference number to identify the depth at which numbers return to background levels; no such reference is available in this case. The trends in these results are consistent with those found by Viers et al. (2012) where soil nitrate concentrations were elevated around 200 mg NO<sub>3</sub>-N/kg near the surface with a slow decrease to 20-50 mg NO<sub>3</sub>-N/kg at depths of 10-15 m. A more detailed comparison is impossible because individual core results, aggregated data, and intermediate depths were not reported in that study. Another study that published soil testing results sampled soil to depths ranging from 1.8 to 4.7 m at 4 beef cattle feedlots in Kansas (Vaillant et al. 2009). A total of 18 soil cores were taken, of which 12 were below their chosen background level (4.1 mg NO<sub>3</sub>-N/kg) for the entire core. The remaining 6 cores had elevated nitrate in the top meter of the core ranging from 10.7 mg NO<sub>3</sub>-N/kg to 510 mg NO<sub>3</sub>-N/kg and a return below the background concentration with increasing depth. Again, the soil testing results from GWMA dairies are similar to these results in magnitude of nitrate concentration, although the nitrate levels at depths greater than 1 m (3.28 feet) were higher in the GWMA soil sampling results than the Kansas feedlot results. Since this study (Vaillant et al. 2009) was the source that the UC Davis researchers (Viers et al. 2012) relied on to identify their high range loading rate of 1,000 kg N/ha-yr, similarity with these results gives us another indicator that this rate is appropriate for use in the GWMA. One large challenge in reviewing literature and comparing results in this field is the diversity of units and species of nitrogen reported in papers. Reporting of nitrogen as nitrate, nitrate-N, organic nitrogen-N, TKN, ammonia/ammonium,

ammonia/ammonium-N, combinations of these, or as total nitrogen is common and makes comparison of literature results difficult and sometimes impossible. Next steps for field research in the GWMA to improve estimates of loading rates from pens should include development and execution of a credible statistical sampling program whose results could be used to develop a GWMA-specific rate with a narrower range.

## LAGOONS

### Methods, limitations, and assumptions

#### *Limitations*

As with the pen identification, every effort has been made in this report to identify facilities and facility uses that are current as of 2015. The distinction between a lagoon, a settling basin, a settling pond, or an irrigation pond can be hard to clarify. Different professionals in this industry use different terms for different manure storage impoundments, and different impoundments may be used for different purposes at different times of year. In addition, producers may mix manure and water in additional impoundments before land application. NRAS has identified lagoon impoundments which are primarily used for storage of manure, as opposed to impoundments which are primarily used for storing irrigation water or which are used for mixing manure and water for land application. These impoundments (primarily used for storing manure) will be referred to as lagoons in this report. This difficulty in classification may result in impoundments being placed in the wrong category, despite NRAS's efforts at accuracy.

Lagoon nitrogen concentrations depend on unit operations onsite and on-farm practices. Variations can include the use of flush versus scrape systems to clean barns, the type and efficiency of solids separation systems used, whether and where irrigation water is mixed with manure for land application, and seasonal effects such as precipitation and evaporation rates. Lagoon nitrogen concentrations used in this report are based on 2 data sources. The first is a relatively large subset of farms in the GWMA (approximately 20) whose operators voluntarily shared lagoon nitrogen testing results with WSDA for this study. The second was EPA's lagoon testing results from 5 dairies sampled in 2010 (EPA 2013a). All testing results from these 2 sources were combined and averaged. The resulting nitrogen concentration is higher than lagoon nitrogen concentrations reported in other studies.

Calculating storage in lagoon subsurface soil was beyond the scope of this report. An accurate calculation would require historic information about dairy and beef cattle numbers, management practices, and lagoon construction practices. However, other research indicates that soil beneath lagoons holds large amounts of nitrogen that could be released and emphasizes the importance of appropriate decommissioning at the end of use (Viers et al. 2012).

#### *GIS methodology and lagoon identification*

Lagoon points included in the geodatabase represent locations for both dairy and non-dairy lagoons. Point locations were derived using latitude and longitude locations from the WSDA DNMP database in conjunction with aerial imagery from Google Maps or USDA NAIP 2013 imagery. Identified lagoon points were compared with DNMP lagoon assessment data followed by direct

consultation with DNMP staff to ensure accuracy. Lagoon area is an attribute and was determined using aerial imagery technology (area = length X width), known dimensions from DNMP (length X width), or using the polygon area (calculated area using GIS) from the DNMP assessment. Depth is also an attribute; depth used was the design depth of the impoundment. Lagoons where the design depth was unknown were assigned an estimated depth, which was the average of all known lagoon depth measurements. Whether depth was the actual design depth or an estimate was documented in an additional Depth Method attribute with values of Actual or Estimate.

The quality assurance procedure conducted for the lagoon points was the same as that for pens and compost areas. Randomly selected points were field surveyed to confirm the identification and accuracy of the lagoon location. Any errors were corrected, and all points were checked against USDA NAIP 2015 imagery.

#### *Lagoon dimensions*

WSDA's DNMP has recently completed a lagoon assessment project following NRCS Technical Note 23 (USDA NRCS 2013). The DNMP staff visited every lagoon on a dairy with a milk license, with the exception of the Consent Order dairies, either 2 or 3 times in 2015 in order to assess the lagoon both when it was near full and near empty. During these assessments staff recorded design length, width, storage capacity, and depth. Length, width, and depth of lagoons were determined from existing nutrient management plans and were likely measured at the time of lagoon construction. If DNMP did not have access to the design dimensions, staff used ArcGIS Collector to obtain the perimeter of the lagoon they visited. Length and width measurements at time of construction and Collector application polygons were taken along the border of the embankment and therefore reflect the area of the lagoon at maximum capacity. Surface area was calculated from the polygon or the length and width measurements.

NAIP imagery was utilized to identify additional lagoons that were not included in this assessment process. DNMP staff was consulted to determine if the impoundments identified in the aerial imagery were lagoons, ponds, or neither. Only polygons identified as lagoons were included in this analysis. NRAS staff used NAIP 2015 imagery to measure the length and width of these lagoons. NRAS staff then randomly selected a population of these lagoons for quality assurance checks. Staff visited each of these randomly selected lagoons to confirm identification and location.

Individual lagoon design depths were used when this data was available. The average design depth of the 105 lagoons with known depths was 11.3 ft. This average design depth was used as the depth for lagoons that did not have a measured design depth.

In addition, at each visit DNMP staff estimated the percentage of the lagoon's total capacity in use, and categorized each lagoon as either empty or full. The percentage of lagoon capacity utilized (and as a result, the liquid depth and surface area) varies depending on both season and on-farm management practices. The same farm may have several lagoons that transition from full to empty and back again throughout the year, while another is consistently full; farms may also use lagoons to store irrigation water in addition to manure or use lagoon contents to operate flush systems. During the lagoon assessment process, DNMP staff visited each lagoon either 2 or 3 times in an attempt to view each lagoon both while it was full and while it was empty.

In an attempt to capture a reasonable average yearly liquid depth and surface area to use, NRAS staff used the information recorded by DNMP staff on repeated lagoon visits during the lagoon assessment process. The total number of lagoons visited in 2015 was 115, of which 102 were visited twice and 13 were visited 3 times. Lagoon utilization (% full) varies dramatically depending on the season, so DNMP generally visited each lagoon during both the summer and the winter to account for seasonal variability. The percentage of total capacity utilized at successive visits to the same lagoon was averaged for each of the 115 unique lagoons visited to generate an average capacity used for each lagoon. This average capacity used for each lagoon was then itself averaged across all lagoons, resulting in an average percent capacity used for 2015 visits of 43%. The depth used in the Darcy's Law calculations is 43% of the actual or estimated design depth.

This percentage depth reduction was also used to adjust the surface area of the lagoons. Surface area of the lagoons was determined based on one of the methodologies discussed above (lagoon assessment or aerial imagery). Because of the side slope of lagoons, a reduction in depth results in a corresponding reduction in surface area. The surface areas used for calculations were adjusted based on NRAS's estimation that a lagoon with a working depth of 43% of its design depth would have a corresponding surface area reduction to 73% of the design surface area. The basis for this estimate is described in Appendix C: Lagoon Surface Area Reduction Methodology.

#### *Lagoon nitrogen concentration*

WSDA relied on pre-existing sources of information on lagoon nitrogen concentration for this study. One source of lagoon total nitrogen concentrations was the EPA's sampling in 2010, which was published in their 2013 report (EPA 2013a). This data set consists of 15 lagoon samples from 5 dairy farms (at each farm, 1 sample was taken at the inflow to the farm's lagoon system, and 2 samples were taken at the outflow of the farm's lagoon system). Influent concentrations were slightly higher than outflow concentrations, but a statistical comparison was not conducted (EPA 2013a). The average of the 5 influent concentrations was 1,317 mg N/L and the average of the 10 outflow concentrations was 1,159 mg N/L. The range of sample concentrations was 290- 1,800 mg N/L with a mean of 1,212 mg N/L (EPA 2013a).

Another source of lagoon nitrogen concentration data was lagoon testing conducted by the dairy producers themselves. Dairy producers are required to take yearly samples of lagoon content and have them analyzed by an accredited laboratory. This is regulatory data used by WSDA's DNMP to assess whether or not producers are making nutrient applications at agronomic rates. The South Yakima Conservation District (SYCD) asked dairy producers to voluntarily share lagoon testing results with WSDA for use in this assessment; SYCD collected testing results from producers, anonymized them, and forwarded the information to WSDA. A total of 23 lagoon total nitrogen testing results were provided. The exact number of dairy farms that shared data is not known; conservation district staff have estimated the number at 20 farms. The sample concentrations ranged from 180 – 3,624 mg N/L with a mean of 949 mg N/L. More detailed analysis of these data sources is presented in Appendix B: Lagoon Nitrogen Concentration Statistical Analysis.

The mean of the SYCD data set is lower than the mean of the EPA data set. There are many potential reasons for this difference. Neither data set was collected using a statistically-based sampling procedure. The SYCD data was voluntarily shared with WSDA; producers with high lagoon nitrogen



concentrations may not have been comfortable sharing their testing results. The EPA study was an effort to identify potential contributors to groundwater contamination; dairies identified for sampling were large, far from other potential nitrate sources, in areas with consistent groundwater flow, and close to drinking water wells with known high nitrate levels. Details of on-farm practices at the dairies in both data sets are unknown. Flush or scrape cleaning systems and the presence and scale of solids separation may affect in-lagoon nitrogen concentrations. At a flush dairy, separated lagoon water is often recirculated to clean barns, while at a scrape dairy, lagoon contents are not generally recirculated. The degree of solids separation depends on the system (and corresponding removal of nitrogen contained in or bound to solids) and will also affect lagoon nitrogen concentration.

NRAS consulted supplemental data provided by DNMP to gain additional information about the types of dairy operations within the GWMA boundary. Of the 52 dairies in the data set, 12 were flush dairies, 39 were not flush dairies, and 1 was out of business. Most (83%) of the dairies have some type of solids separator system on site. A minority of the dairies (25%) rely solely on settling basins for solids separation, while 58% of the dairies have secondary processes including slope screen separators, centrifuges, barrel screen roller presses, screw presses, and gravity flow separation. A small number (15%) of dairies have no solids separation systems.

Total nitrogen concentration data used in other studies varies greatly. The UC Davis report used concentrations of 500 and 1,000 mg N/L for different calculations and estimates (Viers et al. 2012). Dairies in California's San Joaquin Valley have lagoon TKN concentrations between 47 and 2,420 mg N/L (Campbell Mathews et al. 2001). Lagoon nitrogen concentrations from 2 studies in California were reported in a University of California Cooperative Extension publication; they were total N of 164-645 mg N/L and TKN of 670 mg N/L (reported in Pettygrove et al. 2010). Local data was chosen over non-local literature data in an attempt to use the most accurate values. In addition, this provides a more protective estimate since local values were higher than those utilized in the literature. The SYCD testing results were combined with the EPA results, resulting in an average total nitrogen concentration of 1,053 mg N/L (n = 38); this is the value that will be used in the calculations in this section. Calculations in this section can be easily updated if additional data is made available.

#### *Atmospheric deposition and volatilization in lagoons*

The lagoon nitrogen concentration used for calculations in this report was derived from analysis of lagoon samples. Atmospheric deposition of nitrogen onto the surface of lagoons would already be accounted for by this testing, it would become part of the nitrogen content of the lagoon. The lagoon testing results did not include any assessment of the age of the material being tested. Without information about when the material was added to the lagoon and how long it was retained, it would be impossible to determine whether the tested nitrogen concentration represented material that had not yet experienced storage losses or had already experienced storage losses. It was assumed that the nitrogen testing results included a range of fresh and aged manure and that the sample would provide enough variety to be representative.

Since this data already accounts for atmospheric deposition to lagoons, the total area of all lagoons was removed from the atmospheric deposition analysis in section 4. ATMOSPHERIC DEPOSITION.

### *Lagoon liner permeability and thickness*

Current NRCS standards for lagoon liners depend on site characteristics, proximity to wells, depth to groundwater, and soil and aquifer characteristics. Depending on conditions, a site may be considered too vulnerable for lagoon construction or may require the use of a synthetic, compacted clay, or potentially no liner. Rather than specifying hydraulic conductivity or permeability required of liners or underlying soils, current guidelines require that lagoon construction meet required specific discharge rates. These specific discharge rates have been based on historically used permeability of  $1 \times 10^{-7}$  cm/s, with an assumed order of magnitude reduction in permeability due to manure sealing, allowing liner permeability to be  $1 \times 10^{-6}$  cm/s (USDA NRCS 2009). Lagoon liner permeability options were also discussed with some GWMA workgroups in 2015. The groups agreed that 2 liner permeability scenarios should be considered in lagoon seepage calculations. Based on these discussions and limitations in the data available, liner permeabilities of  $1 \times 10^{-7}$  and  $1 \times 10^{-6}$  cm/s were used to determine a low and high rate seepage estimate, respectively.

Construction dates for lagoons in the GWMA are unknown. Without information on how many lagoons were constructed before the 2004 standard, it is impossible to say how many lagoons may have permeabilities higher than  $1 \times 10^{-6}$ . The current NRCS Engineering Handbook and other documentation outlines historic practices and guidance published by NRCS (USDA NRCS 2009, USDA NRCS 2016a, USDA NRCS 2016b).

- Prior to 1990: manure sealing was assumed to significantly reduce seepage from lagoons.
- Late 1980s: A guidance document (South National Technical Center (SNTC) Technical Guide 716) was released specifying that relying on manure sealing to reduce seepage in a finished lagoon was insufficient and specified some site conditions when clay liners should be used.
- 1993: South National Technical Center (SNTC) Technical Guide 716 was updated and reissued. All waste storage ponds are required to have a 1-foot liner and soil must meet certain characteristics (percent fines).
- 1998: Agricultural Waste Field Management Handbook is issued containing material from SNTC Technical Guide 716.
- December 2004, Practice Standard 313 is updated, still requiring a minimum 1-foot liner thickness and adding a required permeability less than  $1 \times 10^{-6}$  cm/s.

Clearly lagoons constructed prior to the current guidance documents are unlikely to meet current NRCS standards. However, no information is available about what seepage might be for lagoons constructed before 1990, or between the 1993 guidance and the 2004 guidance. As a result, it is impossible to estimate what the permeability endpoint would be to estimate a high seepage rate. In addition, lagoon liners can be damaged through inappropriate operation and maintenance activities, which would result in increased leakage rates. The only experimental data on lagoon water loss found was Ham's study of Kansas feedlot and swine lagoons, which identified a seepage rate of 1.1 mm/day. The authors used this rate and experimentally determined depths and liner characteristics of lagoons to calculate a liner permeability of  $1.8 \times 10^{-7}$  cm/s (Ham 2002). A top priority for additional research on potential nitrogen loss from lagoons would be to conduct similar water balance lagoon seepage measurements to determine typical rates for GWMA lagoons. This information could be used to narrow the large range of these estimates.

Although the date of construction is not known, the type of liner was known for most of the lagoons that were part of the DNMP lagoon assessment process. Liner types of the lagoons assessed (n=115) were bentonite amendment (45, or 39%), compacted clay (58, or 50%), flexible membrane (10, or 9%), and unknown (2 or 2%). Current NRCS standards for minimum liner thickness are based on the normal full pool storage depth. The average design depth of lagoons visited by DNMP was calculated to be 11.3 feet. For lagoons with depths of 16 feet or less, the minimum liner thickness required is 1 foot (USDA NRCS 2016a). The average liner thickness of several lagoons studied in Kansas was approximately 1 foot (Ham, 2002). No local data was used to support the 1 foot liner thickness used in the seepage calculations. Based on the current NRCS standard, WSDA has chosen to use the minimum liner thickness required for lagoon seepage calculations.

### *Calculation methodology*

Potential seepage from dairy lagoons was calculated using Darcy's Law. This approach relies both on assumptions derived from the literature (liner permeability and thickness) as well as local information (GWMA lagoon surface areas, depths, and nitrogen concentrations). The result of these calculations is the amount of nitrogen expected to pass through the liner, which is then available to move through the soil profile under some conditions. Transport and fate of nitrogen through the soil profile after exiting the lagoon liner is not within the scope of this study.

For the following calculations, all significant figures were kept until the final nitrogen loss estimate was determined. At this point, calculations were rounded to the nearest 1 ton/year or nearest 1,000 kg/year.

First, the volume of fluid leaving the lagoon was estimated using Darcy's Law, then multiplied by the total N concentration to determine the nitrogen loss from lagoons within the GWMA.

$$Q = k * \frac{(H + d)}{d} * A$$

Where

Q = the calculated volumetric flow rate (L<sup>3</sup>/T)

k = coefficient of permeability (hydraulic conductivity, 1x10<sup>-7</sup> or 1x10<sup>-6</sup> cm/s) (L<sup>3</sup>/L<sup>2</sup>/T)

d = thickness of soil liner (estimated at 1 foot) (L)

H = vertical distance between top of liner and top of liquid storage (L)

A = lagoon area (L<sup>2</sup>)

L = length

T = time

$$N \text{ Loading} = Q * C$$

C = Total N concentration, 1053 mg N/L

### **Results and discussion**

Potential loading was calculated for each individual lagoon within the GWMA boundary. Actual measurements for lagoon depth and surface area were used when available. Estimates for these

parameters were used when actual measurements did not exist as discussed above. An example calculation can be found in Appendix D: Darcy's Law Example Calculation.

Darcy's law calculations were run using the two different permeabilities discussed above ( $1 \times 10^{-7}$  and  $1 \times 10^{-6}$  cm/s) to determine a low and high range estimate. Since this is the only parameter that differed between the two calculation scenarios, the estimated loss for high and low differs by a factor of 10. The medium rate was calculated by averaging the low and high rates. Table 7 displays the results from these calculations. The rate per area was determined by dividing the total loss by the total design surface area of lagoons in the GWMA.

Table 7. Estimated high and low loss rates based on Darcy's law

	<b>Low</b>	<b>Medium</b>	<b>High</b>
<b>N Loss (kg N/year)</b>	129,000	709,000	1,289,000
<b>N Loss (ton N/year)</b>	142	781	1,421
<b>N Loss (kg N/ha-year)</b>	1,518	8,348	15,178
<b>N Loss (lb N/ac-year)</b>	1,354	7,448	13,542

These estimates are much higher than those calculated in the UC Davis study (Viers et al. 2012). The totals are not comparable because of the much larger geographic area studied by the UC Davis authors, but the results can be compared on a per-acre basis. In the UC Davis study, the authors identified several different potential loading rates, including several upper limits via different methods and an expected range for loading under typical circumstances. The UC Davis report determined an upper and an alternative upper value for nitrogen loading of 5,100 tons N/year and 1,100 tons N/year, respectively. Using the total area of lagoons identified in the UC Davis study (3,126 acres) to calculate the loading rates on a per-acre basis give upper limits of 0.35 – 1.63 tons N/ac-yr, or 700 – 3,260 lb N/ac-yr. These upper limits were chosen based on liquid loss rates and lagoon nitrogen concentrations from research reviewed here: Ham 2002, van der Schans et al. 2009, Campbell Mathews et al. 2001, and Pettygrove et al. 2010. This research was conducted in Kansas and California. In addition to these upper limits, the authors of the UC Davis study also chose an estimated loading range based on unpublished data from the Tulare Lake Basin and Salinas Valley of 220 – 2,200 tons N/year. Making the same adjustment for lagoon area of 3,126 acres in the UC Davis study, this results in a loading rate range of 0.07 – 0.70 tons N/ac-yr, or 141 – 1,407 lb N/ac-yr (Viers et al. 2012).

The expected loading range for the UC Davis study is much lower than the range expected in GWMA lagoons from the Darcy's law calculation. The high end of the UC Davis expected loading range is similar to the low end of the GWMA expected range. Even the upper limits of the UC Davis expected loading are extremely low compared to the range identified for GWMA lagoons. One contributing factor is the difference in lagoon nitrogen concentrations between the UC Davis study and this calculation. The UC Davis study estimates were largely based on lagoon nitrogen concentrations of 500 mg N/L, although a lagoon nitrogen concentration of 1,000 mg N/L was discussed in that study also. In contrast, the Darcy's law calculations use a much higher lagoon nitrogen concentration of 1,053 mg N/L, which results in a large increase in estimated losses. In addition, the UC Davis estimates are based on experimentally determined rates, while the Darcy's law calculations are based on a theoretical model that, while it includes real world data on lagoon characteristics, is not calibrated with experimental data on lagoon seepage.

## SETTLING PONDS

Some challenges of identifying settling ponds have been discussed above, in the lagoon limitations. Distinctions between impoundment functions may be difficult to identify and impoundment functions themselves can fluctuate. Different industry experts classify impoundments based on different criteria and experience. In addition, there are a wide variety of different construction techniques and operational techniques for settling ponds and basins. Some are earthen ponds that are drained and cleaned as needed. Some are concrete lined, engineered basins, which would make using permeabilities for a clay lined impoundment inappropriate. The lack of information about the diversity of settling basins and their construction techniques makes it impossible to make reasonable assumptions for calculation. The work involved in correctly identifying and characterizing settling ponds or basins well enough for an accurate calculation makes addressing settling ponds beyond the scope of this report.

## Conclusions and recommendations

This work is intended to be used as a planning and management tool for the GWMA when determining where to use limited resources. Although the best available information has been used to assess nitrogen available for transport, many of these calculations are partially based on literature values and assumptions due to a lack of local data. Current and new work by state agencies may provide additional information about lagoon conditions that could be used to adjust the permeabilities chosen for the Darcy's law calculation: WSDA DNMP's assessment of Yakima County lagoons through the Natural Resources Conservation Service's Technical Note 23 (USDA NRCS 2013) and the CAFO permit recently issued by the Washington State Department of Ecology, which requires producers to assess lagoons by the process in Technical Note 23. However, translating these condition ratings into a functional permeability that could be used in Darcy's law may be challenging.

The single most useful piece of information that could be used to improve this estimate would be measured lagoon seepage rates in the GWMA, which could be used to refine and narrow the range of the lagoon estimate. In addition, both lagoon and corral estimates could be improved through additional statistical sampling of total nitrogen concentrations in lagoons and statistical sampling of soil nitrogen concentrations below pens.

In order to make sure nitrogen losses from corrals and lagoons are as low as possible, producers should be consistent with maintenance and inspection of facilities. Maintenance activities include:

- Check to make sure piping and pumps are free from leaks and operating well.
- Check and maintain lagoon interior to make sure no erosion is occurring at inlet and transfer pipes.
- Check lagoon interior for erosion due to waves caused by wind; repair as needed.
- Maintain an intact manure seal inside lagoons
- Keep vegetation low on the embankments so that burrows and cracks can be detected and repaired.

- Maintain proper freeboard in lagoons to prevent overtopping.
- Protect the manure-soil interface layer in pens; its presence is protective of groundwater.
- Manage pen moisture levels carefully - if the surface dries out completely cracks can form, serving as a channel for contaminants to get through the interface layer, but if liquid is allowed to pool that can also result in liquid movement through the interface layer.

DRAFT

## 2. IRRIGATED AGRICULTURE

WSDA authors: Kelly McLain, Perry Beale, Margaret Drennan, Jaclyn Hancock

### Background

Estimated nitrogen available for transport from irrigated agricultural production (including all nitrogen sources used) is discussed in this section. Use of both manure and commercial fertilizer on cropland associated with dairies is discussed here instead of the CAFO section of the report. In order to determine whether irrigated agriculture in the region is adding nitrogen or removing nitrogen, a mass balance technique was used, in which all inputs and outputs of nitrogen were accounted for. The largest and most complicated inputs in this mass balance are crop fertilizer applications. Crop fertilizer applications are influenced by crop type, crop nitrogen needs, application recommendations, and expected yields. Other inputs and outputs (potential nitrogen fixing, nitrogen removal through crop harvest, irrigation water use, and plant residual removal or incorporation) are also crop dependent. Because of the large number of different crops grown in the GWMA (50 different crop types), WSDA NRAS staff identified the top 15 crops by acreage (based on 2014 WSDA crop data) within the GWMA boundary (WSDA 2015). NRAS staff then interviewed commodity-specific experts to obtain a typical range of use rates for manure, compost, and commercial fertilizer for each of these top 15 commodities. These top 15 commodities represent 96% of the irrigated agricultural land within the GWMA, and irrigated agriculture makes up 57% (approximately 99,000 acres) of the total land area within the GWMA boundary (WSDA 2016). A significant proportion of this acreage (31,790 acres or 32%) is dedicated to crops and land uses (corn, triticale, pasture, and alfalfa) that support livestock operations. The other main crops in the region are tree fruit, grapes (both juice and wine), hops, wheat, mint, and asparagus. Table 8 shows the crops evaluated in this section and their respective acreage within the GWMA (WSDA 2016).

Table 8. Top 15 crops and their acreage in the GWMA

<b>Crop</b>	<b>Acreage</b>
Apple	17,333
Corn (silage)	16,778
Triticale	10,780
Grape (juice)	10,257
Alfalfa	7,989
Pasture	6,731
Cherry	6,336
Hops	5,961
Grape (wine)	5,126
Pear	3,331
Mint	1,418
Wheat	1,283
Corn (grain)	1,166
Asparagus	854
Peach/Nectarine	843

## Methods, limitations, and assumptions

### *Limitations*

This assessment is not intended to evaluate the practices of individual farming operations within the GWMA. Growers are not required to share fertilizer or soil amendment application information with outside entities (like WSDA) unless required through statutory requirement (for dairy operations) or legal discovery. The objective was to determine ranges bracketing commonly used application rates for manure, compost, and commercial fertilizer for the top 15 crops (by acreage) grown within the GWMA boundary. The data collected is categorized by commodity; this allows as much anonymity as possible to agronomists and growers who provided nutrient application information.

This report does not explicitly associate information on irrigation methods with the crop types and mass balance. Irrigation practices can affect the likelihood of nitrogen leaching through the soil profile. In addition, removed from the field relocated through irrigation return flows would represent another output in the mass balance, reducing total nitrogen available for transport to groundwater. In managed irrigation systems, water can be used as many as 4 or 5 times before being discharged from the system. Nitrogen concentration of this water will be increased by repeated use; accurately estimating this was beyond the scope of this study. In addition, it is possible for nitrogen-containing water to leak from unlined irrigation canals; an assessment of this potential was also beyond the scope of this study. Timing of fertilizer applications, plant uptake, irrigation applications, and crop residue incorporation was not part of this study. Timing of these events as well as timing of weather events such as rainfall, snowfall, and freezing temperatures can



all affect whether or not nitrogen in the soil will be taken up by plants, be likely to move with runoff, or be available to leach through the soil profile.

This study does not include information on the use or benefits of nitrogen-fixing cover crops used within the GWMA boundaries. Although cover crops benefit soil health, reduce erosion, and can provide nutrients for future crops, the behavior and cultivation of different cover crops and/or winter crops used in double cropping systems was beyond the scope of this study.

Results from this study were not compared to the Yakima county deep soil sampling results: that was beyond the scope of this study. Grower responses about application practices and soil organic matter content were the only deep soil sampling results used in this study. An analysis of the deep soil sampling results for comparison to the mass balance would provide a valuable opportunity to calibrate and adjust the mass balance results.

This study does not distinguish between nitrogen availability as a result of nitrogen source applied. Commercial fertilizers are formulated to release a specific amount of nutrients at a specific rate over a certain period of time. In contrast, a large amount of the nitrogen present in an application of manure or compost fertilizers is organic nitrogen, which is not immediately available for plant growth. This organic nitrogen will mineralize over time, making more nitrogen available for plant growth for several years after the initial application. The actual nitrogen available in the first and subsequent years depends on the nitrogen source, weather and temperature conditions, and the breakdown rate of the organic matter containing the nitrogen. WSDA did not attempt to account for these nuances of nitrogen availability from different sources; all nitrogen contained in any fertilizer application is assumed to be immediately available in the first year after application, regardless of source.

#### *Data Collection*

Irrigated agriculture is mapped statewide by WSDA and includes the area within the Yakima GWMA boundary. This statewide data was clipped to the Yakima GWMA boundary to contain only those crops grown within the GWMA. The data was updated with WSDA's 2015 crop mapping to reflect current agricultural activities within this area. WSDA did some additional mapping work for field corn to distinguish between grain and silage corn acreage for this project. The crop data is captured in the GIS database as polygons with attributes that include locations, crop type, irrigation method, acres, and if it was documented as organic according to WSDA organic program GIS data.

Fertilizer application data was collected via telephone survey. In order to increase participation, participants' identities were not recorded; the goal was to gather enough data to develop a typical use range that would be used to estimate total usage for each commodity, not tie any application rates to specific farming operations. As mentioned above, data was collected for the top 15 crops (representing 96% of the total irrigated acreage in the GWMA) for applications of commercial fertilizer, compost, and manure.

In order to develop a representative estimate for each crop, WSDA's goal was to survey enough producers and crop consultants to get nutrient application data covering a minimum of 30% of the acreage for each target commodity. There are thousands of individual farms operating within the GWMA boundaries, making farmer-specific data collection very difficult. Crop consultants or

agronomists are used by the majority of commercial farms operating in the valley. There are only a few companies that do this type of work, limiting the number of interviews required to access information. While these consultants are not usually farmers, they create prescriptions for fertilizer applications across multiple crops on many different farms.

The data collection goal was met for all commodities, with the exception of pasture, for which information on only 11% of the GWMA acreage could be collected. In total, WSDA included information about more than 58,000 acres of the 15 targeted commodities, or 61% of the acreage dedicated to those commodities in the GWMA (Table 9). All respondents were asked to provide a range of typical use for the three main inputs (commercial fertilizer, manure, and compost) to create a low and high use estimate, as well as questioned about average use rates (to design a weighted average to include in the final dataset).

Table 9. Acreage in each commodity, with data collection targets and collection results

<b>Commodity</b>	<b>Total acreage of commodity in GWMA</b>	<b>30% goal (acres to collect)</b>	<b>Acreage collected</b>	<b>Percent of total acreage collected</b>
Apple	17,333	5,200	14,165	82%
Corn (silage)	16,778	5,033	11,480	68%
Triticale	10,780	3,234	7,500	70%
Grape (juice)	10,257	3,077	3,849	38%
Alfalfa	7,989	2,397	6,194	78%
Pasture	6,731	2,019	725	11%
Cherry	6,336	1,901	3,826	60%
Hops	5,961	1,788	3,760	63%
Grape (wine)	5,126	1,538	2,500	49%
Pear	3,331	999	1,741	52%
Mint	1,418	425	780	55%
Wheat	1,283	385	490	38%
Corn (grain)	1,166	350	348	30%
Asparagus	854	256	506	59%
Peach/Nectarine	843	253	630	75%

Data about grower's fertilizer use practices was also drawn from the surveys conducted through the deep soil sampling process. A thorough statistical analysis comparing the deep soil sampling results to the WSDA interview data could be used to confirm the accuracy of the survey responses. Unfortunately, out of the commodities surveyed, juice grapes and hops are the only commodities that had multiple responses from both data sources. For the rest of the crops surveyed for this study, the respondents came largely from either the deep soil sampling results or the WSDA NRAS survey, without enough responses from both sources to allow a comparison.

### *Mass Balance*

In a mass balance (in this case, focused on nitrogen) all material moving into or out of a system is accounted for. In this case, the system is defined as a 1-acre crop field. Inputs, or additions of nitrogen to the field, are categorized as positive (+). Outputs, or removals of nitrogen from the field, are categorized as negative (-). In addition, processes that transform nitrogen may be significant, and may result in either an increase (+) of available nitrogen in the field or a decrease (-). All known inputs, outputs, and transformations are summed, and the sign and magnitude of the resulting sum can be used to determine whether there is a net accumulation or a net loss of material in the field, or whether there are unknown material flows or transformations.

$$N \text{ accumulation or loss} = \text{Inputs} \pm \text{Transformations} - \text{Outputs}$$

In this case, the list of inputs and transformations includes:

- commercial nitrogen applications (lb N/ac-yr) (evaluated at low, weighted average, and high values);
- manure nitrogen applications (lb N/ac-yr) (evaluated at low, weighted average, and high values);
- compost nitrogen applications (lb N/ac-yr) (evaluated at low, weighted average, and high values);
- atmospheric nitrogen deposition (lb N/ac-yr) (evaluated at low, medium, and high values);
- irrigation water nitrogen (lb N/ac-yr);
- calculated residual nitrogen incorporated (lb N/ac-yr) (evaluated at low, average, and high for some crops and one value for others);
- soil organic matter conversion to nitrate (lb N/ac-yr) (evaluated at low, average, and high values).

The outputs (or nitrogen losses) are:

- crop nitrogen uptake, removed through harvest (lb N/ac-yr) (evaluated at low, average, and high for some crops and one value for others); and
- nitrogen loss to atmosphere (lb N/ac-yr).

### *Determination of Inputs, Outputs, and Transformations*

**Commercial, manure, and compost nitrogen applications:** Growers and agronomists reported use of commercial fertilizer, manure, or compost, as well as application rates and acreages. In order to account for the use of multiple nitrogen sources, within each commodity the proportion of acres each source was used on was a weighting factor in the final calculation. This weighting factor appears as a multiplier for each nitrogen source and was calculated separately for each commodity and nitrogen source. It was generated by calculating what proportion of acres that nitrogen source was used on out of the total acres of that commodity surveyed. For example, in apple production commercial nitrogen application was reported on 86.3% of the total surveyed acres, so 0.863 is used as a multiplier whenever inputs to apple production from commercial nitrogen applications are calculated. This weighting allows the survey data to be scaled from the hundreds of acres for

which applications were reported to the theoretical 1-acre field the mass balance is calculated for and make standardized comparisons between crops and other nitrogen sources.

The low, medium, and high application rates were drawn directly from the survey results. The low and high rates used were the lowest and highest reported application rates for each nutrient source and commodity. The medium application rate was a weighted average of all single application rates reported where each reported rate was weighted by the acreage that survey respondent controlled before averaging.

Synthetic fertilizers are formulated to release nutrients at a specific rate over a certain period of time. The nitrogen in compost or manure is released over a longer period of time at a lower rate, and these products are often applied to improve soil health in addition to providing fertilization. In soils with a history of regular manure applications, the breakdown of organic matter from applications in previous years combines with the available nitrogen from the current year's application to make the full applied amount of nitrogen available during that growing season. For this calculation, WSDA assumes that growers using manure or compost have been applying manure or compost regularly and the nitrogen content from those materials is considered to be immediately available because of the nitrogen contributions from historic applications.

**Atmospheric nitrogen deposition:** This input is the same for every crop assessed. The low rate for atmospheric deposition for the lower Yakima Valley was taken from the most recently reported (2012) wet and dry atmospheric deposition at the Mt. Rainier National Atmospheric Deposition Program (NADP) station; 1.53 lb/ac (EPA 2016). The medium deposition rate is the result of a 5-day modeled average from December 2015; 2.05 lb/ac. To estimate a high rate, the medium atmospheric deposition was multiplied by a safety factor of 3 to account for potential higher deposition during weather conditions resulting in decreased circulation and poor air quality<sup>2</sup>. More details on the methodology and assumptions for atmospheric deposition can be found in Section 4. ATMOSPHERIC DEPOSITION.

**Irrigation water nitrogen:** The nitrogen input from irrigation water is also unique to each commodity. It is based on the nitrogen content of the lower Yakima River and the irrigation water duty for each commodity. Yakima River nitrogen concentration was taken at the U.S. Geological Survey station on the Yakima River at Kiona during the 2012 irrigation season (April through September) (USGS 2012). This time period was chosen to represent the typical time frame during which irrigation water would be withdrawn for use, including both high flow conditions during the late spring (when nitrogen concentration would be low) and low flow conditions during the late summer (when nitrogen concentration would be high). Summary information about this data set was calculated, and the mean (0.809 mg N/L) of the 10 samples was used in the mass balance (Table 10).

---

<sup>2</sup> Medium and high deposition values were recommended by Dr. Ranil Dhammapala, an atmospheric scientist with Washington State Department of Ecology's Air Quality Program, during a meeting on November 3, 2016.

Table 10. Summary statistics for Yakima River nitrogen concentrations (n=10) (USGS 2012)

Minimum (mg N/L)	0.42
Maximum (mg N/L)	1.26
Mean (mg N/L)	0.809
Standard deviation (mg N/L)	0.366
Median (mg N/L)	0.675

Although the sampling location is located in the mainstem of the Yakima River and downstream of the irrigation districts serving the GWMA agricultural lands, WSDA believes that it serves as a good surrogate for potential irrigation water nitrogen levels in the area. The majority of the irrigation water in the lower Yakima Valley is surface water. Very little groundwater is used for irrigation with the exception of a drought year when use of emergency drought wells is permitted. A detailed analysis of sources of irrigation water was not within the scope of this project.

The second part of this input includes commodity specific irrigation water duty for the 15 commodities included in the mass balance. It also takes into account total precipitation and effective precipitation. The data was provided by the Jim Davenport and the Irrigated Agriculture Working Group (IAWG) of the GWMA. The water duty (in inches) values for apples and cherries were reflective of current use patterns, and were edited by Stu Turner, agronomist and member of the IAWG (Appendix F: Irrigation Water Use).

**Calculated residual nitrogen:** Calculated residual nitrogen is the nitrogen taken up during the growing season that is left in the plant after harvest. This term is based on plant nitrogen uptake during the growing season (which appears in the mass balance as an output) and the amount of nitrogen removed when the crop is harvested. As a result, it is different for each commodity. The components of the residual nitrogen calculation were estimated by the Jim Trull and Scott Stevens, as well as the IAWG and Sunnyside Valley Irrigation District and were based on regularly used resources. Depending on the crop type, the residual nitrogen taken up during the growing season but remaining after harvest may be left in the field and incorporated (as in the case of annual crops) or that residual nitrogen may be retained in the plant, in the new growth of vegetation during the season (as in the case of perennial crops). For perennial crops, some of this new growth will be removed during pruning and through seasonal leaf loss and will eventually still return to the soil, and some may be retained on the plant and not return to the soil. For this analysis, it was assumed that calculated residual nitrogen should be wholly counted as an input to the system for all crop types, despite the fact that some crops may differ in that regard; this is an input that can be varied as more information becomes available. Estimates of nitrogen removed during harvest and the inputs used are presented in Appendix G: Nitrogen Uptake Estimates. This appendix includes data on typical crop yields, nitrogen removed through harvest, nitrogen uptake by the plant during its growing cycle, and estimates of nitrogen applied.

**Soil organic matter conversion to nitrate:** This term represents the breakdown of organic matter (containing nitrogen) to nitrate-nitrogen available for both crop uptake and leaching below the crop root zone. This input was the same for every commodity analyzed. The native organic matter content of most lower Yakima Valley soils is around 1% but when these soils have a history of

organic inputs such as manure, it can increase by 2 to 3 times<sup>3</sup>. This was confirmed by a review of the deep soil sampling results. WSDA reviewed results from the fall and spring sampling of 2015 (Table 11) and decided to use the average organic matter content of 2.17% to represent these soils.

Table 11. Summary statistics of organic matter percentage of sampling in the 2015 Yakima Valley deep soil sampling study (n = 108)

Minimum (%)	0.84
Maximum (%)	4.24
Mean (%)	2.17
Standard deviation	0.69
Median (%)	2.15

In general, organic matter in soils can mineralize to provide between 20 and 65 lbs N/ac per 1% organic matter for crop utilization. However, it is not well understood whether the available N is closer to 20 lbs N/ac or 65 lbs N/ac per % organic matter. Previously, practice has been to allow for a minimum of 20 lbs N/ac per % organic matter; however, based on recent soil testing data in the Yakima Valley it appears that the contribution from organic matter should be increased from 20 lbs N/ac to 35-50 lbs N/ac per 1% organic matter when the fields have a history of manure applications<sup>3</sup>. In this mass balance, WSDA used 2.17% organic matter (based on the deep soil sampling results) and conversion rates of 20, 42.5, and 65 lb N/ac for each 1% organic matter. One source for this soil organic matter content can be manure, and the average 2.17% organic matter content of the soil tested during the deep soil sampling may be due to a history of manure applications on those fields. However, there are a number of agricultural practices that producers use to increase the organic matter content of their soil. Direct seed and no-till practices both leave the soil undisturbed, preventing the rapid decomposition of organic matter that takes place when the upper layers of the soil profile are exposed to the atmosphere. Cover cropping can also be used to increase soil organic matter content.

**Crop nitrogen uptake:** This is the amount of nitrogen taken up by the plant from the soil during the growing season. The crop nitrogen uptake is also part of the calculation for residual nitrogen above. This output is unique for each commodity, and was estimated by the IAWG. This output represents the amount of nitrogen taken up by the crop during the growing season; the estimates, ranges, and sources are detailed in Appendix G: Nitrogen Uptake Estimates.

**Loss to atmosphere:** The numbers used in this output of the mass balance equation were taken directly from Table 36, pages 117-118 of the 2006 NRCS publication “Model Simulation of Soil Loss, Nutrient Loss, and Change in Organic Carbon Associated with Crop Production” (Potter et al. 2006).

The full equation, with all inputs and outputs, is:

---

<sup>3</sup> Personal communication, based on experience and best professional judgment of Virginia Prest, WSDA Dairy Nutrient Management Program manager and agronomist,

*Est. N Loading per year*

$$\begin{aligned}
 &= \left( (Comm\ N \times proportion) + (Compost\ N \times proportion) \right. \\
 &+ (Manure\ N \times proportion) \\
 &+ (Atmos\ N\ Dep + Irrigation\ Water\ N + Calculated\ Residual\ N \\
 &+ N\ Soil\ Conversion) \left. \right) - ((Crop\ Uptake\ N + N\ Loss\ to\ Atmosphere)) \\
 &\times (Total\ Commodity\ Acres)
 \end{aligned}$$

This calculation was used for each individual commodity of the top 15 identified.

*GIS Compilation*

The GIS data for the irrigated agriculture section of this study is stored in a file geodatabase that contains both attributes and spatial locations of this data. It contains five feature classes and one table: YakimaGWMA (polygon, GWMA boundary), WSDACrop\_2015 (polygons, crop identification), Lagoons (points), Ponds (points), and CAFO\_Pen\_Compost (polygons, boundaries of pens and compost areas). This database also contains a table, IrrigatedMassBalance, which contained the mass balance calculations and results.

Metadata is included with the GIS database to further describe the additional aspects of the GIS data. This includes information such as the extent, credits, use limitations, scale, processing environment, author, and spatial reference.

**Results and discussion**

During the data collection phase of the irrigated agriculture component of this report, interviewees were asked what percentage of their acreage were fertilized with commercial fertilizer, manure, or compost. Table 12 shows the results from this portion of the survey; the most commonly used product is commercial fertilizer. The only exceptions are silage corn and triticale where more acres are fertilized with manure than with commercial fertilizer. In this table, crop acres fertilized with multiple products appear more than once. As a result, for some crops the percentages sum to more than 100%. For example, all acres grown (100%) of wine grapes were fertilized with commercial fertilizer. In addition, 20% of the acres of wine grapes were fertilized with compost. As a result the total acres fertilized for wine grapes adds up to 120%: 20% of the acres were fertilized with 2 different products. The only crops where growers or crop consultants reported use of all 3 fertilizer products were hops and triticale. The percentage of acres on which multiple sources were used is calculated in the last column.

Table 12. Summary of fertilizer types used for the top 15 crops by acreage in the GWMA

<b>Crop</b>	<b>Commercial fertilizer (% acres)</b>	<b>Manure (% acres)</b>	<b>Compost (% acres)</b>	<b>Acres using multiple sources (%)</b>
Apple	86.3	0	13.7	0
Corn (silage)	49.6	53.9	0	3.5
Triticale	27.2	74.8	0.8	2.8
Grapes (juice)	91.0	0	11.6	2.6
Alfalfa	91.8	8.2	0	0
Pasture	97.2	2.8	0	0
Cherry	80.5	0	19.5	0
Hops	97.3	2.7	16.0	16
Grapes (wine)	100.0	0	20.0	20
Pear	76.6	0	23.4	0
Mint	100.0	0	0	0
Wheat	93.9	22.4	0	16.3
Corn (grain)	71.3	62.6	0	33.9
Asparagus	100.0	0	0	0
Peach/Nectarine	81.0	0	19.0	0

Application rates reported by growers are presented in Table 13. The range of application rates is first, followed by the weighted average (used for the medium rate applications) in parentheses. For several crops (apples, alfalfa, and pears), some growers reported using no commercial fertilizer during some years. For almost all crops, the range spans an order of magnitude between low and high. This indicates the diversity of practices used by different growers. It also suggests that some growers are customizing application rates to crop needs each year, based on soil testing results.



Table 13. Ranges of application rates (with weighted average in parentheses) reported for commercial fertilizer, manure, and compost

<b>Crop</b>	<b>Commercial fertilizer (lb N/ac)</b>	<b>Manure (lb N/ac)</b>	<b>Compost (lb N/ac)</b>
Apple	0-150 (60)	0 (0)	15-100 (47) (47)
Corn (silage)	40-434 (214)	20-324 (203)	0 (0)
Triticale	60-225 (107)	20-350 (104)	170 (170)*
Grapes (juice)	50-100 (80)	0 (0)	21.5-90 (64)
Alfalfa	0-210 (74)	10-300 (161)	0 (0)
Pasture	50-200 (120)	17 (17)*	0 (0)
Cherry	20-125 (56)	0 (0)	15-72 (52)
Hops	25-225 (192)	132 (132)*	30 (30)*
Grapes (wine)	15-40 (25)	0 (0)	36.6-54.9 (46)
Pear	0-100 (57)	0 (0)	15-80 (58)
Mint	80-300 (269)	0 (0)	0 (0)
Wheat	60-120 (106)	90-240 (131)	0 (0)
Corn (grain)	100-300 (214)	50-220 (135)	0 (0)
Asparagus	40-100 (99)	0 (0)	0 (0)
Peach/Nectarine	30-80 (51)	0 (0)	15-30 (28)

\*When no range was reported only a single value is presented in this table.

To better understand the role different nutrient sources play in the amount of nitrogen available for transport, the mass balance inputs were examined (Figure 5). All inputs other than nutrient applications were categorized together (“Other”). The “other” category includes atmospheric deposition, irrigation water concentration, calculated residual nitrogen, and soil organic matter conversion; these inputs are not directly influenced by fertilizer applications. The magnitude of this category is largely determined by calculated residual nitrogen and soil organic matter conversion. Calculated residual nitrogen is unique to the individual crop type, while soil organic matter conversion is related to soil properties and the same calculation was used for all crops. For most crops, fertilizer applications consist mostly of synthetic fertilizer. Some exceptions are corn (silage and grain) and triticale, some of which consistently receive manure applications and are often grown to support dairy operations.

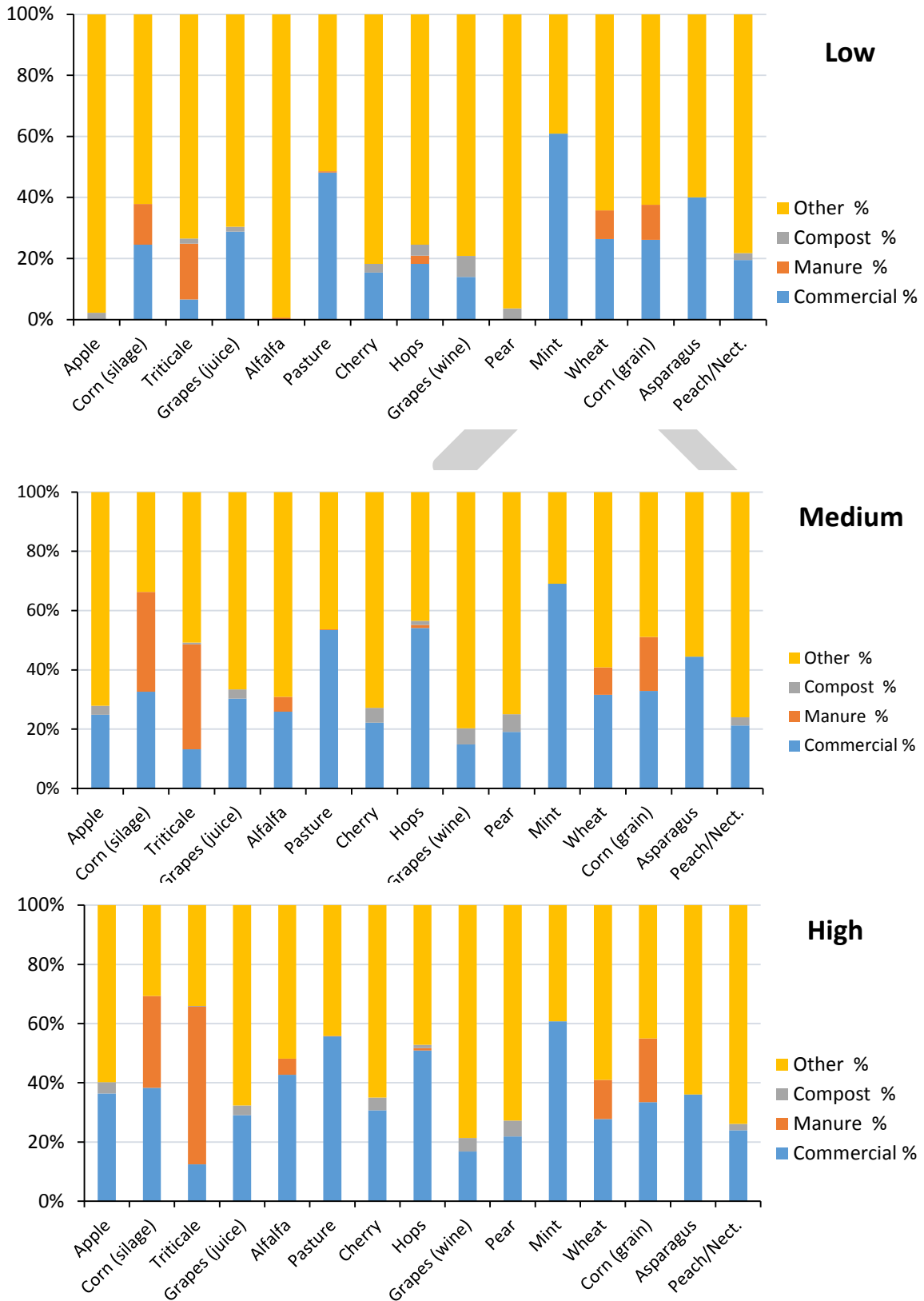

Figure 5. Inputs in the irrigated agriculture mass balance

Data on irrigation practices was collected through WSDA’s agricultural land use mapping (Figure 6). For this report irrigation types were divided into 4 main categories based on whether the irrigation type is likely to result in water loss through the soil and contribute to available nitrogen: sprinkler, micro, macro, and miscellaneous. This information is summarized for both all the irrigated acreage in the GWMA and for the top 3 crops in terms of nitrogen surplus per acre (identified in Table 14).

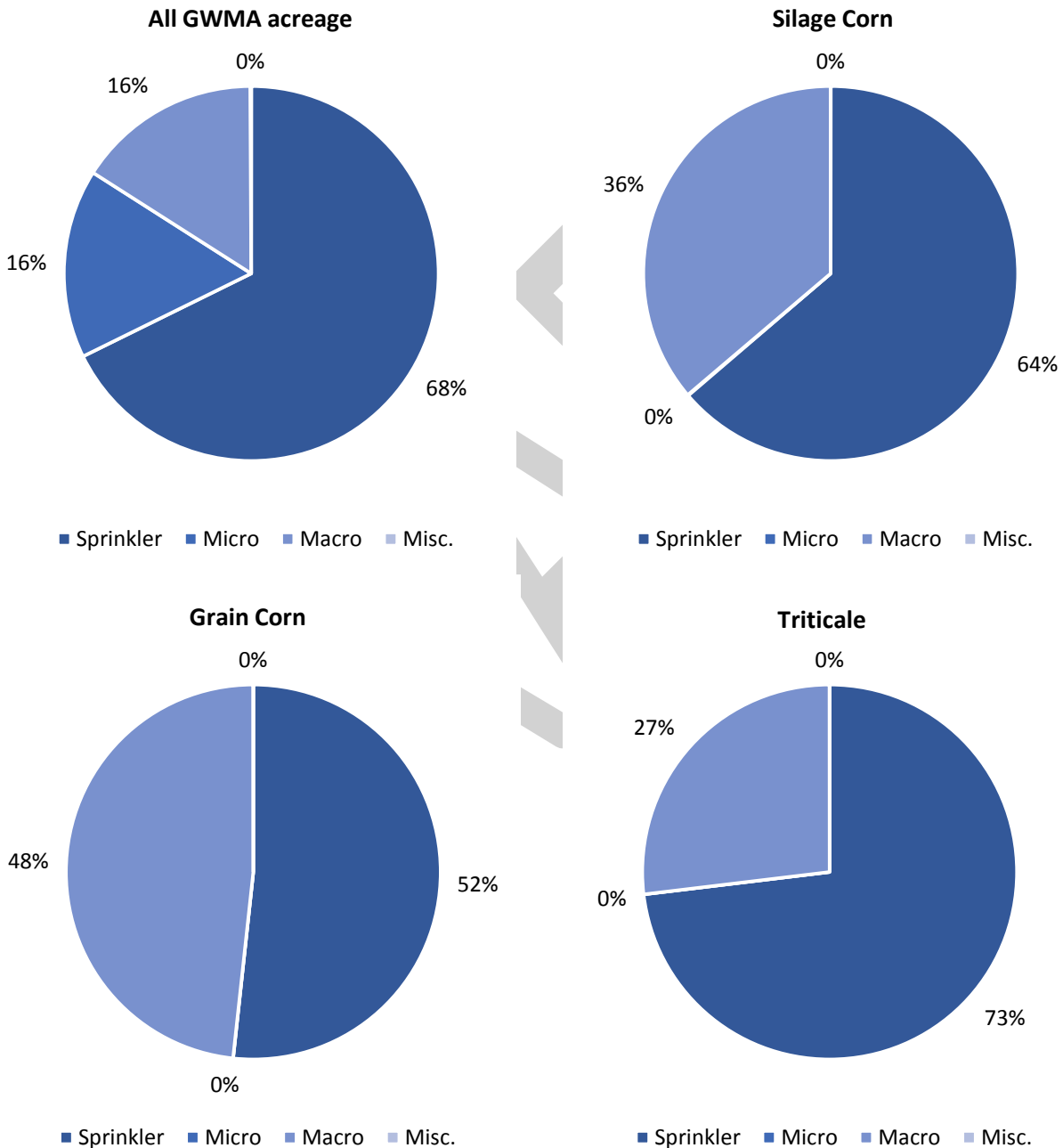

Figure 6. Irrigation types for all GWMA acreage and top 3 commodities with surplus nitrogen inputs (per acre). Due to rounding, categories with 0% are either 0 or values less than 1 that rounded to 0.

The most used irrigation type in the GWMA's irrigated acreage was sprinkler irrigation, which includes center pivot, big gun, sprinkler, wheel line, and combinations of these. Of the total irrigated acreage in the GWMA, sprinkler irrigation was used on 68%. Micro irrigation was the second most common and accounts for about 16% of the irrigation. Micro irrigation includes drip, micro sprinkler, drip/sprinkler, and combinations. The third most common was macro irrigation which includes flood, rill, and combinations with the sprinkler group; macro irrigation accounted for almost as much acreage as micro irrigation, accounting for over 15% of the GWMA acreage (these values have been rounded in Figure 6). The miscellaneous group included irrigation by hand or acreage for which the irrigation type is unknown; this group made up less than 1% of the irrigated acreage in the GWMA.

Because of the potential for irrigation type to affect nitrogen leaching, the irrigation types for the top 3 crops with nitrogen surpluses on a per acre basis (silage corn, grain corn, and triticale) were also analyzed individually. For each of these crops, over 50% of the acreage was irrigated with sprinklers. For silage corn, the second most common technique is macro irrigation (the most likely to result in excess water application and leaching), which accounts for approximately 36% of the acreage. Macro irrigation is also the second most commonly used irrigation type for both grain corn and triticale, used on 48% and 27% of the acreage, respectively. Micro irrigation and miscellaneous irrigation types were used on less than 1% of the acreages of silage corn, grain corn, and triticale. Without detailed information about water loss through excess application, nitrogen content of lost water, and soil testing results, WSDA was unable to specifically relate the individual irrigation practices to any potential nitrogen surpluses.

The results of the mass balance equation are shown below for the 15 commodities evaluated (comprising 96% of the total irrigated agricultural acreage in the GWMA). These values represent the estimated nitrogen surplus resulting from one year of inputs and outputs. These estimates do not account for nitrogen already present in the soil before fertilization. Values shown in Table 14 include low, average, and high potential nitrogen surplus in lb/ac-yr for each commodity resulting from one year's worth of applications and removals. Negative values represent a localized removal of nitrogen and do not offset excess nitrogen from other crops or areas within the GWMA.

Table 14. One year's worth of inputs and outputs for the top 15 crops in the GWMA

Commodity	Acreage	Sum of inputs and outputs for one year (lb N/ac-yr)		
		Low	Medium	High
Apple	17,333	-5	91	219
Corn (silage)	16,778	-200	25	242
Triticale	10,780	-135	-9	250
Grapes (juice)	10,257	61	132	197
Alfalfa	7,989	-365	-236	-46
Pasture	6,731	-186	-68	62
Cherry	6,336	27	105	210
Hops	5,961	-84	78	113
Grapes (wine)	5,126	40	94	156
Pear	3,331	-1	92	173
Mint	1,418	-166	73	157
Wheat	1,283	-79	23	113
Corn (grain)	1,166	-48	126	284
Asparagus	854	58	157	210
Peach/Nectarine	843	12	81	158

At the low end of the range, the sum of one year's worth of inputs and outputs for many crops is less than zero. The survey results these calculations are based on include both typical year-after-year application practices and a range of practices which should encompass both a producer's best possible year (where high nitrogen in a pre-plant soil test allowed a producer to make very low or even no nitrogen applications) and worst possible year (where a producer needed to make high nitrogen applications to meet crop growth needs). In addition, a net negative sum from a year's worth of inputs and outputs doesn't mean that there is no nitrogen loss during the year – losses may still take place after fertilizer applications if heavy rainfall or irrigation applications take place before plant growth uses the applied nutrients. However, the presence of these low values in the range of practices suggests that producers are responsive to the information in pre-plant soil tests and work to tailor nutrient applications to crop growth needs as possible. Successive years with a net nutrient deficit are likely to be followed by higher nitrogen applications to maintain yields.

Table 15 has been shaded to illustrate which commodities, based on our survey, have agricultural practices that may remove nitrogen (green) or add excess nitrogen (yellow) to the system. Commodities that have a negative value for the sum of the inputs and outputs are displayed with a dashed line to reduce confusion. Practices used on these crops are not making nitrogen available for transport (considered over the course of a year) nor are they removing excess nitrogen available from fertilization practices of another commodity. Only positive values are summed for the totals estimated in the low, medium, and high scenarios.

Table 15: Sum of inputs and outputs for the top 15 crops in the GWMA (entire acreage)

Commodity	Estimated total N surplus in GWMA (ton N/yr)		
	Low	Medium	High
Apple	-	786	1,897
Corn (silage)	-	208	2,029
Triticale	-	-	1,346
Grapes (juice)	312	677	1,008
Alfalfa	-	-	-
Pasture	-	-	209
Cherry	87	333	666
Hops	-	232	337
Grapes (wine)	103	240	400
Pear	-	153	288
Mint	-	52	111
Wheat	-	14	72
Corn (grain)	-	74	165
Asparagus	25	67	90
Peach/Nectarine	5	34	67
Total	532	2,870	8,685

A nonzero result in a mass balance (Table 15) can indicate either unknown inputs, outputs, or transformations, or net accumulation or loss. Of the 15 crops assessed, 10 did not have a yearly nitrogen surplus when evaluated at the low range estimates. Only juice grapes, cherries, wine grapes, peaches/nectarines, and asparagus had calculated nitrogen surpluses at the low range. At the high level, the majority of crops had calculated excess nitrogen. The only crop that did not was alfalfa.

Alfalfa was not estimated to have a nitrogen surplus at any evaluation level (low, medium, or high). Alfalfa is a complex perennial crop. It removes large quantities of nutrients from the soil (Koenig et al. 2009). It can meet most of its nitrogen needs from the atmosphere through nitrogen fixation, but is dependent both on the presence of rhizobia bacteria in the soil and on whether or not supplemental nitrogen is added. Alfalfa is considered a “lazy” plant and will use nitrogen from other sources such as manure or commercial fertilizer if given the chance. The practice of nitrogen supplementation on alfalfa does occur within the GWMA. However, agricultural practices used for perennial crops like alfalfa and pasture remove the majority of the plant residue from the field during harvest (hay/silage) or through grazing, which may contribute to the fact that these crops largely did not have calculated nitrogen surpluses.

One of the reasons for differences in the excess nitrogen for different commodities lies in the unique cultivation practices for each crop. The orchard and vineyard crops listed above (apples, grapes, cherries, pears, and peaches/nectarines) are permanent crops. Producers of these crops don't have access to options like crop rotations or fumigation to deal with disease and pest pressure and as a result may rely on tools like high nutrient applications or applications of multiple nutrient sources in order to improve soil health and maximize fruit production. In addition, producers of crops intended for human consumption may be reluctant to make manure and compost applications because of concerns about pathogen transfer, reducing their fertilization options further. The majority of manure and compost applications observed were taking place on crops intended for animal feed or prior to planting permanent crops.

Annual crops such as silage corn, grain corn, triticale, and wheat use both commercial nitrogen and manure throughout the GWMA. Triticale is double-cropped (2 crops in one growing year) with silage corn, and triticale cultivation occurs on almost all sprinkler or center pivot irrigated fields in the GWMA. Triticale cultivation rarely occurs on rill irrigated fields. In this case, triticale is planted in the fall, harvested in the spring (April-May) with silage corn, wheat, or oats seeded immediately afterward and harvested late summer or fall (August-September). Generally, the nitrogen application for this corn/triticale cropping system is split – 1 application in the fall and 1 in the spring. Corn (silage and grain) use fairly even amounts of commercial nitrogen and manure on most of the acreage.

The crops with the highest estimated total nitrogen surplus (over the entire GWMA) aren't necessarily the crops with the highest surpluses per acre. The top 4 crops in terms of nitrogen surplus are also the 4 crops with the highest cultivated acreage. There are crops with comparable or higher nitrogen surpluses per acre (cherries, grain corn, and asparagus) but these crops are cultivated on far fewer acres. They may still represent localized risk to groundwater.

The mass balance sums at low, medium, and high range were combined with WSDA's cropland data layer to generate maps showing which areas of the GWMA have nitrogen surpluses under low, medium, and high range scenarios (Figure 7, Figure 8, and Figure 9). In these maps, commodities without calculated nitrogen surpluses are all represented as green while those with calculated nitrogen surpluses are represented as pink (0 – 500 ton N/yr) and red (greater than 500 ton N/yr).

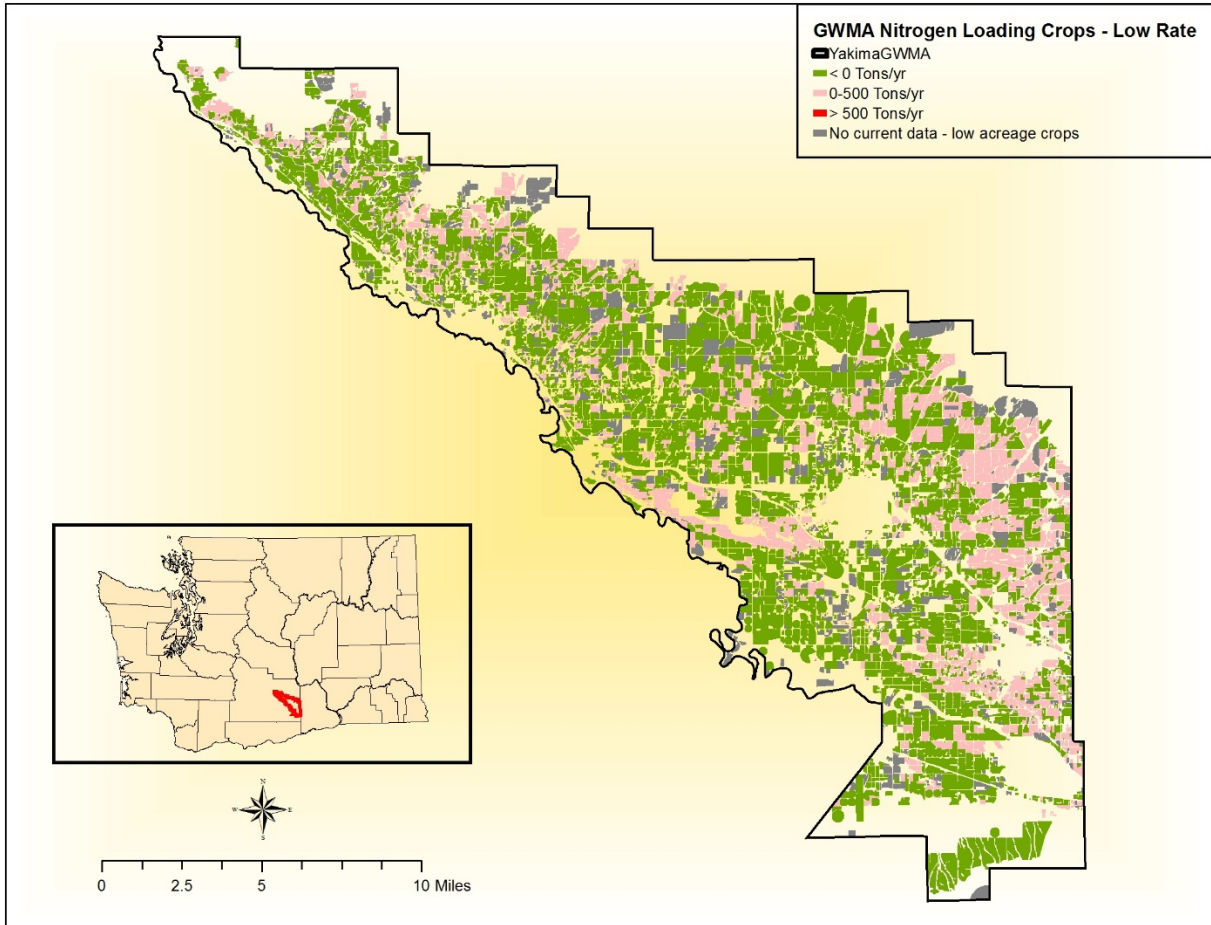

Figure 7. Map of Yakima GWMA with low range nitrogen availability estimates

DRAFT



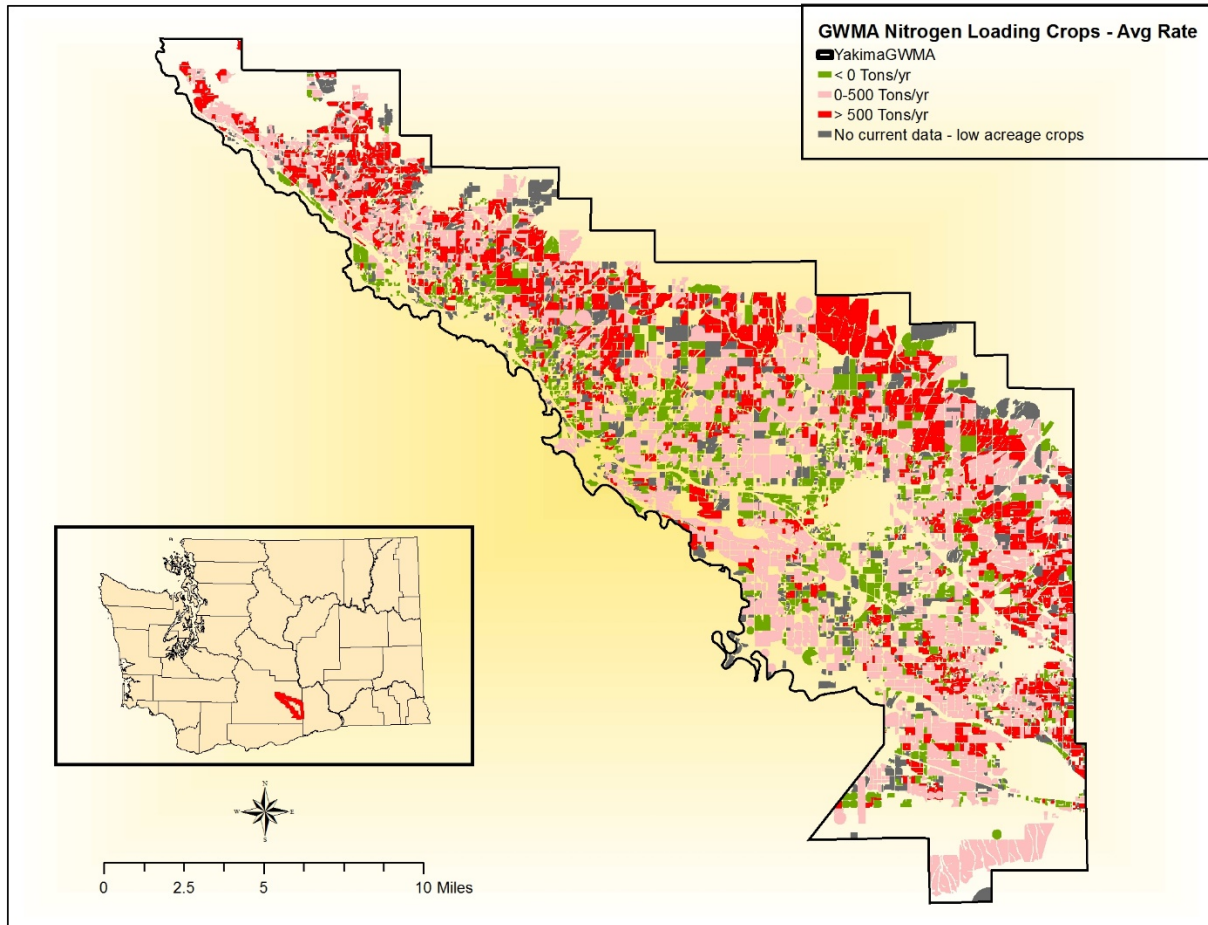

Figure 8. Map of Yakima GWMA with medium range nitrogen availability estimates

DRAFT

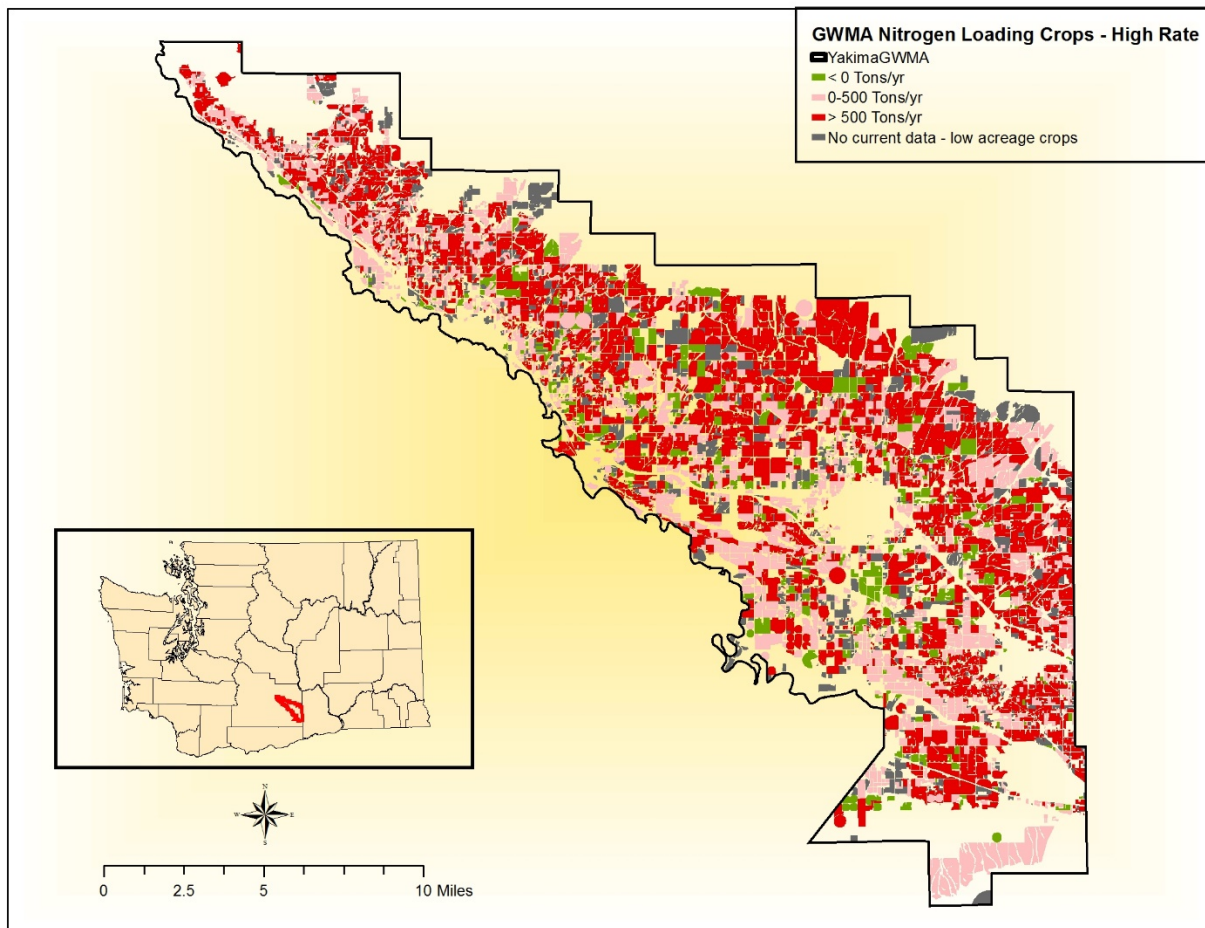

Figure 9. Map of Yakima GWMA with high range nitrogen availability estimates

Based on the information gathered through the survey and crop mapping, it is impossible to identify which part of the range (low, medium, or high) is the most likely scenario. It is likely that there are producers and crop types whose application practices occupy all parts of the range (some making low range applications, some making high range applications). Nutrient application decisions are complicated and depend on expected crop pricing, anticipated yields, recommendations from crop consultants and fertilizer guides, historical practices, and practices of other growers in the community. This variability, in combination with effects of fertilizer types used, irrigation type and practices, and nutrient application timing, will all affect whether or not any fertilizer application will result in a nitrogen surplus. Additional variation comes from soil type and organic matter content, soil nutrient content, manure nutrient content, handling, and storage before application, organic carbon cycling and mineralization, and fertilization and nitrogen fixing in alfalfa.

### Conclusions and recommendations

Based on this initial survey data, WSDA has identified specific commodities where nitrogen surpluses could result in available nitrogen that could move from the soil profile into groundwater

in the lower Yakima Valley. This information can be used to identify target regions where excess nitrogen is high or risk to groundwater may be elevated (based on available data like depth to groundwater or soil type). In addition, WSDA has identified both next steps to improve this study and recommendations for research that would supply useful information to growers making fertilization decisions:

- The next priority for additional work on the mass balance calculations should be comparing the estimated nitrogen surpluses from the different commodities to the deep soil sampling results for validation and improvement of the nitrogen mass balance.
- Most Washington State University Extension fertilizer guidance dates to the 1970's; updating and expanding this guidance would make a valuable information source available to growers. Information on considerations when combining nutrient applications from commercial sources with manure and compost applications should be included.
- Field research on the following topics would provide growers with information about the fate of fertilizer applications, plant uptake, and nitrogen availability from different fertilizer sources:
  - in-depth evaluation of potential nitrogen surpluses on higher risk and larger acreage crops and crops that receive applications of commercial fertilizer, manure, and compost combined;
  - research on manure nutrient content, manure application strategies, and the subsequent fate of nitrogen, other nutrients, and salts;
  - research to better understand organic matter in soils including plant nitrogen availability;
  - the long-term agronomic, environmental, and economic feasibility of available sustainable management practices.

### 3. RESIDENTIAL, COMMERCIAL, AND INDUSTRIAL SOURCES

Yakima County authors: Cynthia Kozma, Michael Martian, Vern Redifer, P.E.

#### Background

Yakima County GIS Department was tasked with evaluating the nitrogen loading potential from non-agricultural sources within the GWMA boundaries. For this this assessment, the analysis was divided into five distinct categories:

1. Residential Onsite Sewage Systems (ROSS)
2. Large Onsite Septic Systems (LOSS)
3. Commercial Onsite Septic Systems (COSS)
4. Residential Lawn Fertilizers
5. Hobby Farms

This also includes a separate analysis for migrant worker impacts within the ROSS category.

#### Residential On-Site Sewage Systems

The Yakima County GIS Department developed a model to determine the nitrogen loading from individual residential on-site sewage systems located within the GWMA.

#### *Methods*

The Yakima County GIS Department incorporated all data sources having a geographical or spatial aspect into the county's GIS. The following was determined using geospatial analysis:

- There are 6,044 households within the GWMA that discharge wastewater to a ROSS. Figure 10 shows the location of each ROSS. The relative density of ROSS within the GWMA is shown in Figure 11.
- The average number of persons per household for each household discharging to a ROSS was obtained from census tract data provided by (OFM 2010). The household size used in the loading calculations for each ROSS is equal to the average household size for the census tract containing the household. The average household size for households discharging wastewater to a ROSS is 3.5 persons per household. The average household size ranges from 2.72 persons per household to 4.16 persons per household.
- The approximate location of each ROSS was determined. A ten foot buffer was graphically drawn around the building footprint to provide the best estimation of where a ROSS for each building would be located. If a parcel did not have a building footprint available, then a point was generated in the center of the parcel.
- The soil type underlying the approximate location of each ROSS was determined using (USDA NRCS 2014). Using GIS, the specific soil type was determined at each residential property within the GWMA and then each soil type was classified according to description to determine its corresponding maximum hydraulic loading rate based on Table VIII of

WAC 246-272A-0234. Table 16 shows the soil classifications, infiltration rate for each soil classification, and the number of ROSS within each soil classification (On-Site...2005)

Table 16. Maximum hydraulic loading rate

Soil type	Soil textural classification description	Loading rate for residential effluent (gal/sq. ft-day)	Number of ROSS
1	Gravelly and very gravelly coarse sands, all extremely gravelly soils excluding soil types 5 & 6, all soil types with greater than or equal to 90% rock fragments.	1.0	
2	Coarse sands.	1.0	
3	Medium sands, loamy coarse sands, loamy medium sands.	0.8	
4	Fine sands, loamy fine sands, sandy loams, loams.	0.6	
5	Very fine sands, loamy very fine sands; or silt loams, sandy clay loams, clay loams and silty clay loams with a moderate structure or strong structure (excluding a platy structure).	0.4	5,961
6	Other silt loams, sandy clay loams, clay loams, silty clay loams.	0.2	69
7	Sandy clay, clay, silty clay and strongly cemented firm soils, soil with a moderate or strong platy structure, any soil with a massive structure, any soil with appreciable amounts of expanding clays <sup>1</sup>	Not suitable	14

- Using the approximate location of each ROSS, a land elevation was determined at each site using the GIS land elevation contours. It is important to note that the GIS land elevation model was derived by interpolating between 10 foot contours developed by aerial photogrammetry.
- The estimated depth to groundwater measured from the land surface at the approximate location of each ROSS. It is important to note that GIS groundwater elevation model was derived by interpolating between 25 foot contours developed by (Vaccaro et al. 2009).

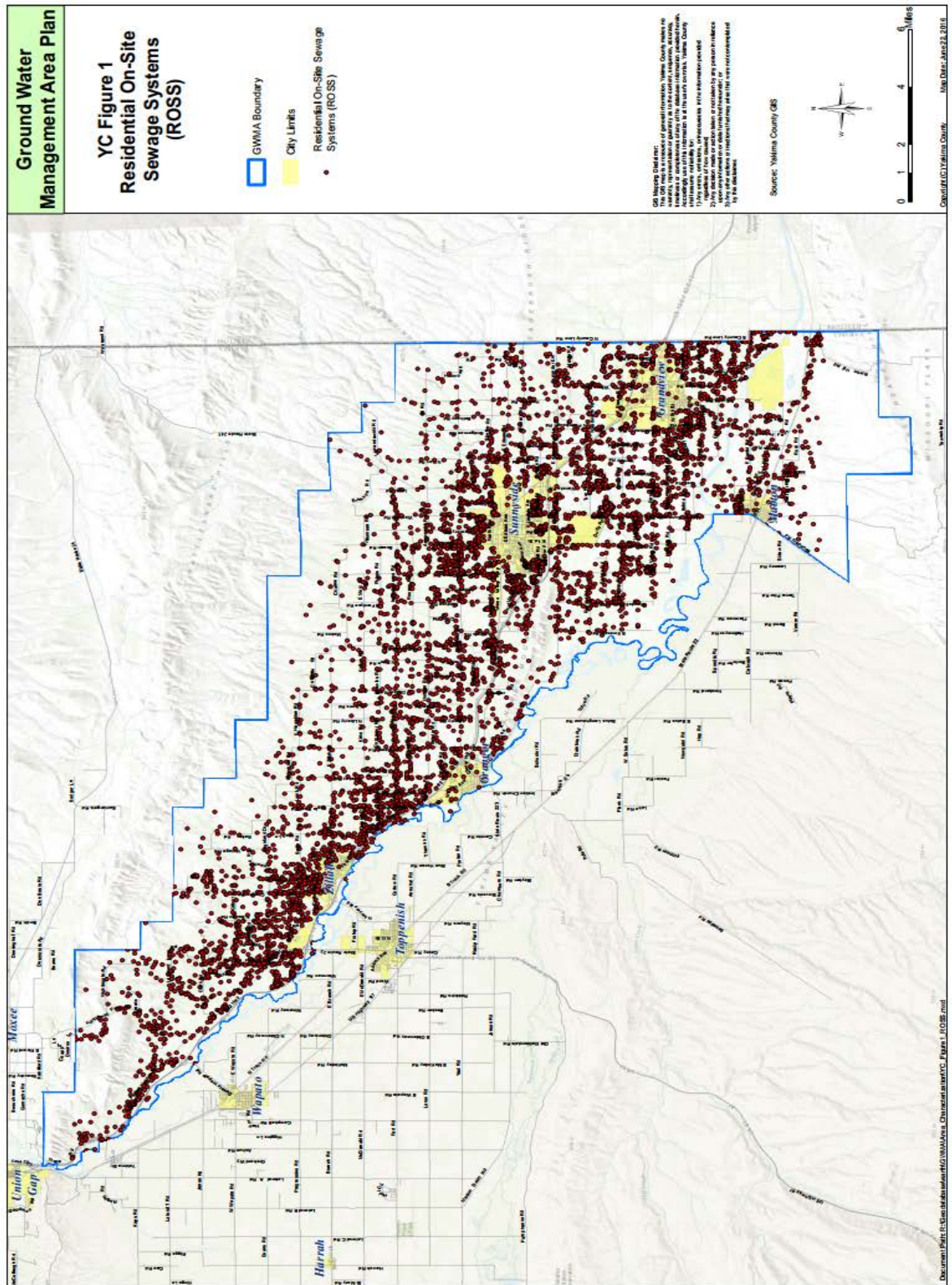

Figure 10: Residential on-site sewage systems

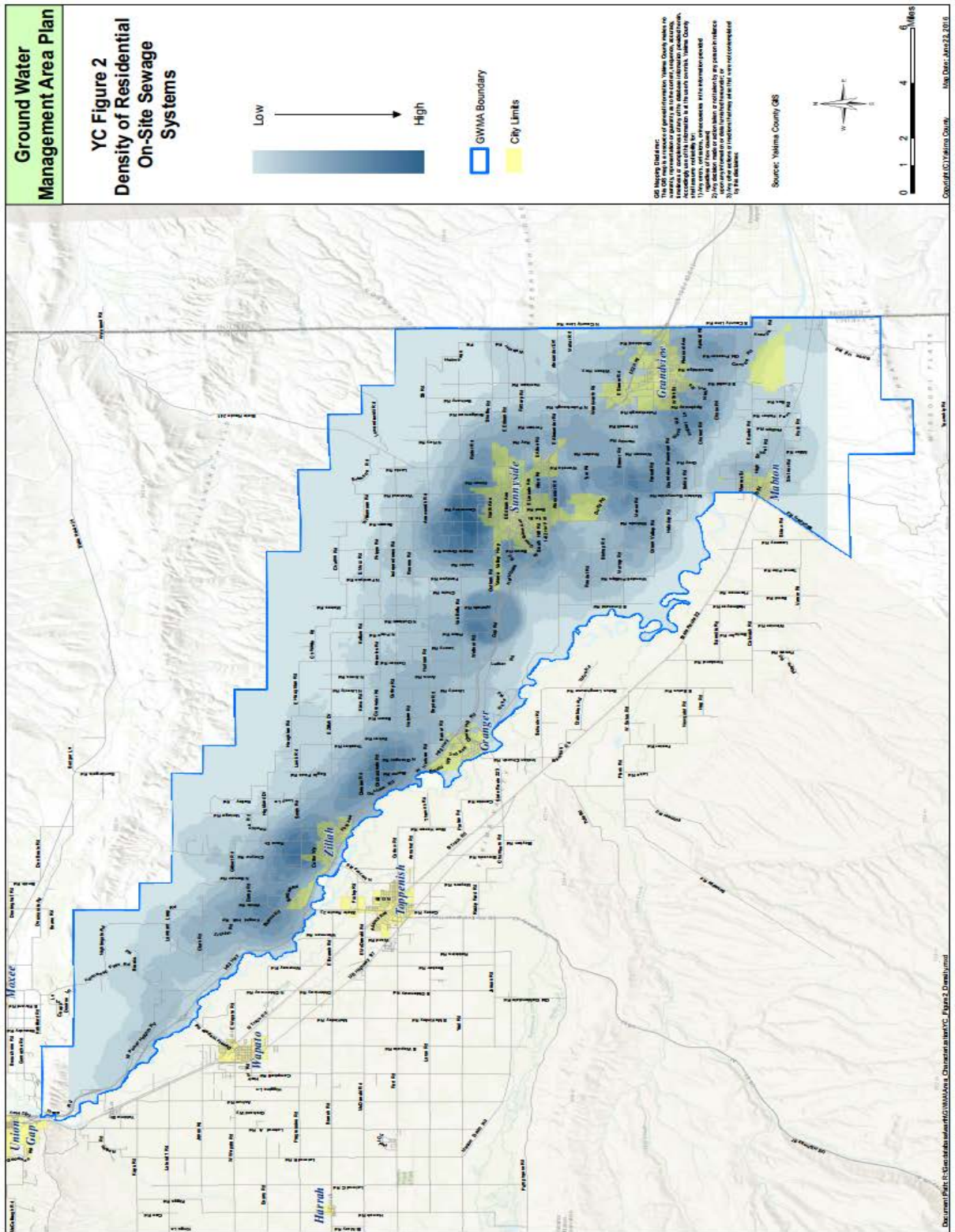

Figure 11. Density of residential on-site sewage systems

### *Nitrogen Loading to a ROSS*

Nitrogen in residential wastewater is mainly generated from human body wastes and food materials from kitchen sinks and dishwashers. The amount of nitrogen present in the wastewater is typically expressed as a concentration in milligrams per liter (mg/L) and/or as a mass loading in grams/person/day. This assessment of nitrogen loading from on-site sewage systems utilizes the mass loading approach.

Table 3-7 of (EPA 2002a) reports that the total nitrogen (TN) loading to a ROSS ranges from six to seventeen grams per person per day and assumes a water use of 60 gallons/person/day (227 liters per person per day). Table 4.4 of (EPA 1992) reports the total nitrogen loading to a ROSS is approximately 11.2 grams per person per day. The nitrogen mass loading assessment for the residential on-site sewage systems within the GWMA utilizes a high, medium, and low approach. Accordingly, this ROSS assessment assumes a nitrogen loading of 17, 11.2, and 7 grams TN per person per day. These mass loading rates equate to TN concentrations of 26.4, 49.3, and 74.8 mg/L respectively assuming a water use of 227 liters/person/day Note: WAC 246-272A-0230 *Design Requirements-General* under section (2) (E) (ii) requires that designs for on-site systems, other than systems for single-family residences, be designed in accordance with (EPA 2002a) (On-Site...2005).

### *Nitrogen Removal by Denitrification*

Wastewater discharged to a ROSS is subject to several biological processes including nitrification and denitrification. These processes can take place depending on the environmental conditions and occur most effectively when the soil is unsaturated because the wastewater is forced to percolate over the soil particle surfaces where treatment can take place and air is able to diffuse through the soil. Whether these processes occur and their effectiveness in treatment depends on the physical characteristics of the soils and the environmental conditions of the soil through which the wastewater percolates. Wastewater parameters, such as levels of nitrogen are removed to varying degrees. Organic or ammonia nitrogen is readily and rapidly nitrified biochemically in aerobic soil and some biochemical denitrification can occur in the soil, but without plant uptake, 60 to 90 percent of the nitrate enters the ground water. Under anaerobic soil conditions, nitrification will not occur, but the positively charged ammonium ion is retained in the soil by adsorption onto the soil particles. The ammonium may be held until aerobic soil conditions return allowing nitrification to occur (EPA 1992).

Factors found to favor denitrification are fine-grained soils (silts and clays) and layered soils (alternating fine-grained and coarser-grained soils with distinct boundaries between the texturally different layers), particularly if the fine-grained soil layers contain organic material. However, it is difficult to predict removal rates for wastewater-borne nitrate or other nitrogen compounds in the soil matrix (EPA 2002a). Table 3-17 (EPA 2002a) provides examples from studies conducted in 1976 and 1977 that showed that 10 to 40 percent of the total nitrogen can be removed by denitrification by soil infiltration in a conventional drainfield. In 1990, Jenssen and Siegrist found in their review of several laboratory and field studies that approximately 20 percent of nitrogen is lost from wastewater percolating through soil (EPA 2002a).

The predominant soil type underlying the ROSS drainfields located within the GWMA are characterized as very fine sands, loamy very fine sands; or silt loams, sandy clay loams, clay loams



and silty clay loams with a moderate structure or strong structure (Table 16). The estimated depth to groundwater is equal to or greater than 10 feet at approximately 90% of the ROSS locations. When considered together, this information is useful to the extent that it is reasonable to assume that the environmental conditions underlying the drainfields are conducive to some level of denitrification. Accordingly, taking a conservative approach and relying on (EPA 2002a), this nitrogen mass loading assessment, in keeping with a high, medium, and low approach, uses denitrification percentages of 10, 15, and percent respectively. Plant uptake for this assessment is assumed to be zero.

#### *Nitrogen Removal by Septage Pumping*

WAC 246-272A-0010 defines a septic tank as “a watertight treatment receptacle receiving the discharge of sewage from a building sewer or sewers, designed and constructed to permit separation of settleable and floating solids from the liquid, detention and anaerobic digestion of the organic matter, prior to discharge of the liquid.” “The mixture of solid wastes, scum, sludge, and liquids pumped from within septic tanks, pump chambers, holding tanks, and other OSS components.” is defined as septage (On-Site...2005).

The total nitrogen content of septage generated in the GWMA is not available. However, Table 2-2 *Characteristics of Septage Conventional Parameters (1)* contained in (EPA 1994) reports that the average Kjeldahl nitrogen in septage is 588 mg/L with a range from 66 mg/L to 1060 mg/L. Accordingly, this assessment uses an average concentration in septage of 588 mg/L total nitrogen.

WAC 246-272A-0232 establishes the minimum liquid volume for a septic tank serving a single family residence as 900 gallons for a residence containing 3 or fewer bedrooms, 1,000 gallons for a four bedroom residence, and an additional 250 gallons per bedroom for each bedroom over four. The actual septic tank size at each OSS within the GWMA is unknown. For analysis purposes, this assessment assumes that the tank size at each ROSS meets, and is equal to, the minimum WAC requirements of 900 gallons (3,407 liters) (On-Site...2005).

The amount of nitrogen removed by pumping a 900 gallon tank when it is full using TN = 588 mg/L and a 900 gallon (3,407 liters) septic tank is 2.0 Kg (4.417 pounds). The effective annual rate of TN removal by septic tank pumping can be estimated by taking the TN removed by pumping and dividing by the length of time in years between pumping events. Similarly, the reduction in TN concentration in wastewater entering the septic tank compared to the wastewater leaving the septic tank can be estimated by taking the TN removed by pumping and dividing by the total water entering the septic tank during the time between pumping events. Doing so, using an average household size of 3.5 persons and a per capita water use of 60 gallons per day, results in TN concentration reductions of 2.3 mg/L, 1.4 mg/L, and 0.7 mg/L for 3, 5, and 10 year pumping events respectively.

WAC 246-272A-0270 makes the owner of a ROSS responsible for operating, monitoring, and maintaining their ROSS including the requirement to employ an approved pumper to remove the septage from the tank when the level of solids and scum indicates that removal is necessary (On-Site...2005). The frequency of septic tank pumping at each ROSS in the GWMA is unknown. However, the Groundwater Advisory Committee for the GWMA initiated a “Well Assessment Survey” that was conducted by the Yakima Health District for 458 households within the GWMA. That

survey included the question “Have you had your septic tank pumped recently?” Of the 458 surveys completed, 82% of the respondents answered “yes” and 18% of the respondents answered “no” or “I don’t know.” This survey, though not a valid statistical sampling (survey respondents volunteered and were not necessarily geographically dispersed), does provide information that indicates that the majority of households within the GWMA are more than likely having their septic tanks pumped periodically. Typical maintenance guidelines recommend that a septic tank be pumped every 3 to 5 years (EPA 2002b). Accordingly, this nitrogen mass loading assessment, in keeping with a high, medium, and low approach, assumes septic tank pumping occurs every 10, 5, and 3 years respectively.

### Model Input Summary

Table 17 summarizes the inputs used for estimating the nitrogen loading from residential septic tanks:

Table 17. Input parameters for estimating total nitrogen from ROSS

Parameter	Units	Low	Medium	High
Household Size	Persons / Household	Census Tract Average	Census Tract Average	Census Tract Average
TN Loading to ROSS	gm/person/day	7	11.2	17
Denitrification	Percent	20	15	10
Septic Tank Size	Liters	3,407	3,407	3,407
TN in Septage	gm/L	0.588	0.588	0.588
TN in Septic Tank When Pumped	gm	2,003	2,003	2,003
Septic Tank Pumping Frequency	Years	3	5	10

### ROSS Results

#### Model Output Summary

The low, medium, and high estimated net nitrogen loads from all of the ROSS within the GWMA using the input factors contained in Table 17 are 43.7 tons, 79.2 tons, and 130.3 tons respectively. The estimated nitrogen loads are summarized in Table 18.

Table 18. ROSS nitrogen loading estimate

	Units	TN Generated by 6,044 Households	Denitrification	Average Annual TN Removed by Pumping	Total N
LOW	Grams/Year	54,636,835	(10,927,367)	(4,035,377)	39,674,091
	Lbs/Year	120,454	(24,091)	(8,896)	87,466
	Tons/Year	60.23	(12.05)	(4.45)	43.73
MEDIUM	Grams/Year	87,418,937	(13,112,840)	(2,421,226)	71,884,870
	Lbs/Year	192,726	(28,909)	(5,338)	158,479
	Tons/Year	96.36	(14.45)	(2.67)	79.24
HIGH	Grams/Year	132,689,457	(13,268,946)	(1,210,613)	118,209,898
	Lbs/Year	292,530	(29,253)	(2,669)	260,608
	Tons/Year	146.27	(14.63)	(1.33)	130.30

### About the Model

The model created for this assessment is maintained by the Yakima County Public Services Department. It has been designed such that it provides the ability to estimate the nitrogen loading from ROSS within the GWMA by changing any or all of the input parameters. As an example, using a denitrification rate of 15%, a TN Loading to a ROSS of 11.2 gm/person/day, and a septic tank pumping frequency of 4 years results in a TN of 78.3 tons.

### Migrant Worker Effect on ROSS Nitrogen Loading

The number of persons living within the GWMA has a direct effect on the nitrogen loading from septic tanks and the above ROSS assessment only accounts for those persons living within the GWMA boundary on a permanent basis. Yakima County agricultural producers supplement their work force during peak periods by hiring migrant workers. A migrant worker is defined as a farm worker whose employment requires travel that prevented the worker from returning to his/her permanent place of residence the same day (USDA NASS 2014). In 2012 there were 9,598 migrant workers employed by agriculture throughout all of Yakima County (USDA NASS 2014). It is not known precisely where these migrant workers were employed or where they lived. However, it is possible to estimate the number of migrant workers working in the GWMA boundary by prorating the total number of migrant workers for the county by acres of crop land in Yakima County. This approach assumes that the estimated amount of migrant workers working within the GWMA also resided within the GWMA.

There are 360,906 acres of crops in Yakima County with 99,976 (28%) of those acres located within the GWMA (WSDA 2016). Prorating the number of migrant workers by crop acres results in a GWMA migrant worker population of 2,687 migrant workers (28% of 9,598). (USDA NASS 2014) does not provide information relative to the amount of time each migrant worker worked - a worker working just one day is recorded as one migrant worker and a worker working 30 days is also reported as one migrant worker. On the other hand, (ESD 2015), reports the total number of agricultural workers by month employed, but does not report the number of migrant workers. Nonetheless, by assuming that the monthly migrant workforce reported by (USDA NASS 2014)

follows the same trending pattern as the total monthly agricultural workforce reported by (ESD 2015), an estimate of an annualized migrant population can be derived. Doing so results in an average annual migrant population within the GWMA of 224 persons (2,687 person months ÷ 12 months = 224 persons). Table 19 shows the calculations for the estimated migrant worker population. Consequently, employing the same methodology used for residential ROSS, the estimated additional TN loadings per year from migrant workers using the low, medium, and high format are 0.50 tons, 0.90 tons, and 1.40 tons respectively.

Table 19. Migrant workforce estimate

Month (A)	Total County Ag Workers / Month (B)	Monthly Distribution of Total County Ag Workers / month by % of Total ('C)	Prorated Migrant County Ag Workers / month = (B) X ('C) (D)	Prorated GWMA Migrant Ag Workers / yr = ('C) X 28% ÷ 12 (E)
Jan	20,120	0.058	555	13
Feb	22,540	0.065	622	15
Mar	23,220	0.067	640	15
Apr	25,540	0.073	704	16
May	26,410	0.076	728	17
Jun	38,550	0.111	1,063	25
Jul	39,920	0.115	1,101	26
Aug	33,080	0.095	912	21
Sep	38,440	0.110	1,060	25
Oct	35,720	0.103	985	23
Nov	24,320	0.070	671	16
Dec	20,130	0.058	555	13
Totals:	347,990	1	9,598	224

#### Nitrogen Loading from ROSS per Land Area

Nitrogen loading estimates per land area were determined using the OSS design requirements contained in WAC 246-272A-0230 as a means of comparing the nitrogen loading from ROSS with other potential nitrogen sources that are typically land area based. According to the WAC, the design flow for an OSS is determined by multiplying the number of bedrooms by 120 gpd based on an occupancy of 2 persons per bedroom. This results in a design load of 60 gpd per person per day. The design flow for each ROSS is estimated by multiplying the household size by 60 gpd (a household size of 4.16 persons would have a design flow of 250 gallons per day). It is important to note that the minimum design flow established by the WAC is 240 gallons per day<sup>0</sup> (On-Site...2005).

The area of the drainfield for a ROSS is used to estimate the land area where nitrogen discharged from a septic tank is applied. The size of this area for each ROSS is estimated by first dividing the design flow for the ROSS by the infiltration rate for the soils underlying the drainfield. A household with a design flow of 250 gpd in a soil having an infiltration rate of 0.45 gallons/ft<sup>2</sup>/day would have

an estimated infiltrative surface of 556 ft<sup>2</sup>. Second, taking a simple approach, the size of the drainfield can be approximated by assuming that infiltration trenches are one foot wide and 60 feet long (60ft<sup>2</sup>/ trench) and that the lateral separation between trenches is five feet resulting in the need for 10 trenches and a drainfield size of 60 feet by 45 feet or 2,700 ft<sup>2</sup>. Finally, the nitrogen loading per land area can then be estimated by dividing the annual nitrogen load for the ROSS by the area of the drainfield. If the above household has a TN discharge of 28 lbs/yr, then the annual nitrogen loading per land area is 0.01 lbs/ft<sup>2</sup> (436 lbs/acre).

The size of each ROSS drainfield was estimated using the above methodology resulting in a total drainfield area for all of the ROSS in the GWMA of 398 acres. Consequently, the TN loadings summarized in Table 20 result in low, medium, and high land application rates of 223 lbs/acre, 403 lbs/acre, and 662 lbs/acre respectively. Total loadings from ROSS drainfields are summarized in Table 20.

Table 20: Estimated Total Nitrogen Loadings from ROSS Drainfields

	<b>Low</b>	<b>Medium</b>	<b>High</b>
Loading (lb N/acre)	223	403	662
Loading (kg N/hectare)	249	452	743
Loading (ton N/year)	44.2	80.1	131.7
Loading (kg N/year)	40,131	72,663	119,461

## Large On-site Septic Systems

### Background

A Large Onsite Septic System is a septic system having a design volume over 3,500 gallons. The design and operation of LOSS are overseen by the Washington State Department of Health (WDOH). WDOH records show that there are 2 LOSS located within the GWMA. The design capacity, location, and times of use of both of the LOSS were provided to the GIS Department by WDOH.

### LOSS Results

One LOSS site is located outside of Zillah (Zillah LOSS) with a design capacity of 5,000 gallons. This LOSS serves the employees of a large fruit packing operation and warehouse. The LOSS is used by employees throughout the year with peak use during the fruit packing season. It is presumed that the loading to the LOSS is predominantly human waste from toilet flushing. The average loading generated by toilet flushing is 16.2 gallons/capita/day with a nitrogen loading of 8.7 grams/capita/day (EPA 1992) at Tables 4-2 and 4-4. WAC 246-272 B 06450(4) (b) requires that the size of a LOSS septic tank be equal to 3 times the daily design flow (Large...2011). As such, the design flow for the 5,000 gallon tank is 1,667 gpd. Dividing the design flow by 16.2 g/cap/day equates to 103 persons per day. The annual nitrogen loading from 103 persons, using the ROSS methodology and substituting a TN loading of 8.7 grams/capita/day, is a low of 575 lbs/year, a medium of 612 lbs/year, and a high of 649 lbs/year or 0.29 tons/year, 0.31 tons/year, and 0.32 tons/year from the Zillah LOSS. Of note is that this estimate is based on the peak loading during the packing season and does not reflect a smaller work force during the remainder of the year.

The second LOSS site is located outside of Granger (Granger LOSS) with a design capacity of 4,850 gallons. The design flow is 1,620 gpd (one third of the size of the tank). This LOSS serves migrant workers for approximately 30 days each year during the cherry harvest season. It is presumed that the migrant workers reside at this site and that the loading to the LOSS is typical of the loading to ROSS. Accordingly, the number of persons this LOSS was designed to serve is 27 persons. Using the same methodology used to calculate the total nitrogen load for ROSS, a nitrogen load for the LOSS was determined. This results in a low of 9 lbs/year, a medium of 16.0 lbs/yr and a high 27 lbs/year of total nitrogen from the Granger LOSS. Results from LOSS systems are summarized in Table 21.

Table 21: Estimated Loading from LOSS systems

	<b>Low</b>	<b>Medium</b>	<b>High</b>
Loading (lb N/acre)	195	209	225
Loading (kg N/hectare)	218	235	252
Total loading (ton N/year)	0.29	0.31	0.34
Total loading (kg N/year)	265	285	307

## Commercial On-site Septic Systems

### Background

The term “Commercial” Onsite Septic Systems, as used in this report, refers to septic systems that are used for employees working at agricultural businesses that operate year-round and are not classified as a LOSS by WDOH. The most likely location for these facilities within the GWMA are at confined animal feeding operations (CAFOs).

### COSS Results

The Washington State Department of Agriculture reported that there were 52 operating CAFOs located within the GWMA in 2014. Each CAFO was classified by WSDA by herd size ranges as shown in Table 22. Presumably, each CAFO provides a restroom facility for its employees. It is not known if the facilities are a COSS or some type of portable facility. This nitrogen loading assessment for COSS assumes that there is a COSS at each CAFO location.

It is assumed that the loading to the COSS is predominantly human waste from toilet flushing. The number of employees at each CAFO is unknown but can be estimated using a paper published by the University of California in 2004 titled “*For Wages and Benefits, Bigger Dairies May be Better*” written by Barbara Reed (Reed 1994). The following is extracted from that paper:

**Number of employees:** Larger dairies had a higher cow-to-employee ratio than smaller dairies. Dairies of more than 700 cows averaged 151 cows per employee; dairies with fewer than 250 cows averaged 82 cows per employee. Dairies with fewer than 250 cows employed 3.5 workers on average; dairies with more than 700 cows employed 12 workers. The largest number of employees reported for any dairy was 31 (1,900 cows).

This assessment uses a cow to employee ratio of 82 for CAFOs smaller than 700 cows and a cow to employee ratio of 151 for CAFOs larger than 700 cows. The number of cows is assumed to be the highest number in the range, with 8,000 cows used for the largest CAFOs. This methodology is represented in Table 22.

Table 22. GWMA CAFO herd size and employee estimate

Mature Herd Range (cows)	Number of CAFOS	Employees/ CAFO	Total Employees
200 to 699	14	9	126
700 to 1699	18	11	198
1700 to 2699	10	18	180
2700 to 3699	4	25	100
3700 to 4699	1	31	31
4700 to 5699	1	38	38
5700 to 6839	2	45	90
6840 and above	2	53	106
Total	52		869

The average loading generated by toilet flushing is 16.2 gallons/capita/day with a nitrogen loading of 8.7 grams/capita/day (EPA 1992) at Tables 4-2 and 4-4. The annual nitrogen loading from 869 persons, using the ROSS methodology and substituting a TN loading of 8.7 grams/capita/day, is a low of 4,865 lbs/year, a medium of 5,170 lbs/year, and a high of 5,475 lbs/year. Results from COSS are summarized in Table 23.

Table 23: Estimated Loading from COSS

	Low	Medium	High
Loading (lb N/acre)	163	173	183
Loading (kg N/hectare)	182	194	205
Total loading (ton N/year)	2.43	2.59	2.74
Total loading (kg N/year)	2207	2345	2483

## Residential Lawn Fertilizer

### Methods

The overall nitrogen loading assessment includes an estimate of nitrogen from fertilizers applied to residential lawns located within the GWMA. The GIS Department developed a method for approximating the area of maintained lawn areas. This method involved the use of ArcMap Spatial Analysis and color infrared orthophotography to determine “green” spaces within the residential areas of the GWMA. The infrared photography shows actively growing vegetation as variations of red on the orthophotography.

A classification tool in ArcGIS was “trained” to search for these red spots and identify them as grass, trees, or shrubs. These areas represent a “green” layer within the GIS and are considered areas where fertilizer may be applied. Using the green layer, four representative areas within the GWMA were examined to determine the percentages of land area that were green. Each of the areas were

one square mile in size and the buildings and crop lands were subtracted from the green areas. The four areas examined were:

- An urban area located within the City of Sunnyside city limits (Urban) representing urban density properties. The average parcel size for this urban area is 0.28 acres and the amount of green area is 33.4% of the total acreage resulting in an average green area per parcel of 0.09 acres.
- A suburban area located outside the City of Sunnyside, but within the Sunnyside Urban Growth Boundary (Suburban), representing suburban density properties. The average parcel size for this suburban area is 4.95 acres and the amount of green area is 25.2% of the total acreage resulting in an average green area per parcel of 1.25 acres.
- A rural area that encompasses the unincorporated community of Outlook (Rural High) representing rural properties within the GWMA that are relatively small in size. The average parcel size for this suburban area is 4.90 acres and the amount of green area is 13.0% of the total acreage resulting in an average green area per parcel of 0.64 acres.
- A rural area within the County (Rural Low) representing rural properties within the GWMA that are relatively large in size. The average parcel size for this rural area is 23.7 acres and the amount of green area is 3.1% of the total acreage resulting in an average green area per parcel of 0.73 acres.

Table 24 summarizes the representative areas.

Table 24. Representative lawn areas in the GWMA

<b>Representative Area</b>	<b>Average Parcel Size (acres)</b>	<b>Green Area (acres)</b>	<b>Percent Green</b>	<b>Green Area per parcel (acres)</b>	<b>Green Area per parcel (sf)</b>
Urban	0.28	20.04	33.4%	0.09	4,074
Suburban	4.95	161.28	25.2%	1.25	54,337
Rural High Density	4.9	83.2	13.0%	0.64	27,748
Rural Low Density	23.7	19.84	3.1%	0.73	32,004

Residential lawn areas for the entire GWMA were approximated using Table 24 values and the following criteria:

- Each residential parcel located within an incorporated City was given a lawn area of 0.09 acres.
- Each residential parcel located within an urban growth boundary and outside of an incorporated city was given a lawn area of 1.25 acres.
- Each residential rural parcel (outside of an urban growth boundary) that had a total parcel area equal to or less than 5.0 acres was given a lawn area of 0.64 acres.
- Each residential rural parcel (outside of an urban growth boundary) that had a total parcel area greater than 5.0 acres was given a lawn area of 0.73 acres.

Table 25 summarizes the approximated total lawn area within the GWMA using the above criteria:



Table 25. Residential lawn areas

Representative Area	Application	Green Area per Parcel (acres)	Number of Parcels	Green Area in GWMA (acres)
Urban	All parcels located in incorporated cities	0.09	7,180	646
Suburban	All parcels located in UGA outside of cities	1.25	892	1115
Rural high density	All rural parcels <= 5 acres	0.64	3,285	2102
Rural low density	All rural parcels > 5 acres	0.73	709	518
Totals			12,066	4,381

The lawn care practices used by residents within the GWMA are unknown relative to the amount of nitrogen applied to their lawns each year. Anecdotal evidence indicates that some residents fertilize their lawns regularly and some do not fertilize their lawns at all. Consequently, this estimate for the amount of nitrogen used on lawns within the GWMA is entirely based upon the assumption that residents that do fertilize their lawns do so once each year using a typical commercial lawn fertilizer such as Scotts® Turf Builder. This product's application guidelines equate to the application of 23.3 pounds of nitrogen per acre for each application. (13.35 lb. bag, 20-0-8 analysis, covers 5,000 sf).

#### *Residential Fertilizer Use Results*

In keeping with the high, medium, and low approach, it is assumed that the percent of residents who fertilize are 80, 50, and 20 percent respectively. Accordingly, the high nitrogen loading estimate is 40.8 tons, the medium estimate is 25.5 tons, and the low estimate is 10.2 tons. It is important to note that this lawn loading assessment does not take into consideration any nitrogen lost to plant uptake, denitrification, and volatilization as is normal practice. Given the coarseness of the assumptions contained in the assessment already, it is believed that any further refinement is unjustified. Table 26 shows the low, medium, and high estimated loading from residential fertilizer use.

Table 26: Estimated N loading from Residential Fertilizer

	Low	Medium	High
Loading (lb N/acre)	4.7	11.7	18.6
Loading (kg N/hectare)	5.2	13	20.9
Total loading (ton N/year)	10.2	25.5	40.8
Total loading (kg N/year)	9,260	23,152	37,043

### **Small-Scale Commercial and Hobby Farms**

#### *Background*

“Small-scale commercial and hobby farms” is a term used in this report to represent residential land uses other than lawns that may contribute nitrogen to the GWMA area. These land uses are

attributable to relatively small parcels that that are not included in the Washington State Department of Agriculture’s Crop inventory. Nitrogen contributions on these parcels may come from individual gardens, pastures, pets, and other animals.

*Methods*

The GIS Department developed an ArcGIS model to determine the potential number of hobby farms in the GWMA. To do so, using the GWMA parcel information, all parcels located within the city limits were removed, all parcels greater than 10 acres were removed, non-residential properties were removed, and parcels that overlapped with the WSDA’s Cropland Data Layer were removed. The remaining parcels were then categorized into 3 size categories - (1) Acres  $0 \leq 2.5$ , (2) Acres  $\geq 2.51$  and Acres  $\leq 5.00$ , and (3) Acres  $\geq 5.01$  and Acres  $\leq 10.0$ . Once the parcels were categorized, the parcels were matched to the residential lawn data in order to remove the lawn area from the parcel area and to eliminate double counting of nitrogen loading. In addition, a building allowance of 2,000 ft<sup>2</sup> for each parcel was also deducted from the parcel area to arrive at an effective area for hobby farms.

*Small-Scale Commercial and Hobby Farms Results*

The analysis yielded the results shown in Table 27.

Table 27. Parcel size and total acres

<b>Parcel Size Range of Small-Scale Farm (acres)</b>	<b>Number of Parcels</b>	<b>Total Parcel Area (acres)</b>	<b>Lawn Area (acres)</b>	<b>Building Allowance @ 2,000 sf/parcel (acres)</b>	<b>Effective Area (acres)</b>
0 to 2.5	2335	2,481.5	1,804.1	107.2	570.2
2.51 to 5.0	311	1,075.6	223.0	14.3	838.4
5.1 to 10.0	110	776.1	83.3	5.1	687.7
Totals	2756	4,333.2	2,110.4	126.5	2,096.3

The recommended amount of fertilizer applied to each of these groups as proposed by the GWMA’s RCIM Work Group is shown in Table 28. In keeping with the high, medium, and low approach, it is assumed that the percent of residents who fertilize are 80, 50, and 20 percent respectively similar to the assumption for residential lawn fertilizer.

Table 28. Percent of fertilizer application by hobby farm size

<b>Parcel Size of Small-Scale Farm (acres)</b>	<b>Nitrogen Fertilizer Application (lb/acre/yr)</b>	<b>Nitrogen Fertilizer Application (kg/hectare/year)</b>
$0 \leq 2.5$	14	15.7
$2.51 \leq 5.0$	21	23.5
$5.01 < 10.0$	28	31.4

The loading rate was then applied to the corresponding Small-Scale Farm size using the effective area. The results are shown in Table 29.

Table 29. Total nitrogen loading for hobby farms

Parcel Size of Small-Scale Farm	Small-Scale Farm Effective Area (acres)	Application (lbs)	TN Low at 20% (tons)	TN Medium at 50% (tons)	High at 80% (tons)
0 ≤ 2.5 Acres	570.2	14	0.80	2.00	3.19
2.51 Acres ≤ 5.0 Acres	838.4	21	1.76	4.40	7.04
5.01 Acres ≤ 10.0 Acres	687.7	28	1.93	4.81	7.70
<b>Total (ton N/year)</b>			<b>4.48</b>	<b>11.21</b>	<b>17.94</b>
<b>Total (kg N/year)</b>			<b>4,068</b>	<b>10,171</b>	<b>16,273</b>

DRAFT

## 4. ATMOSPHERIC DEPOSITION

WSDA author: Kelly McLain

### Background

Atmospheric deposition is the process by which aerosol particles collect or deposit themselves on the earth's surfaces. It can be divided into two general sub-processes: dry and wet deposition. Nitrogen emissions in the Pacific Northwest may come from transportation, agriculture, power plants, industrial, and natural sources. In coastal areas, transport of nitrogen due to emissions in Southeast Asia may also be a source. In urban areas, emissions will mainly be in the form of oxidized sulfur compounds ( $\text{NO}_x$ ) while in agricultural areas emissions from fertilized cropland and CAFOs will be largely in reduced forms (ammonia and ammonium). In general, emissions of both oxidized and reduced nitrogen have been increasing in recent decades (Fenn 2003). Emissions may travel distances ranging from meters to thousands of kilometers before subsequent wet (through precipitation) or dry redeposition takes place (Viers et al. 2012). Monitoring of deposition is conducted by the National Atmospheric Deposition Program, which conducts both monitoring of and modeling of N species emissions concentrations and deposition throughout the United States. Monitoring is conducted mainly at fairly remote sites; there are 5 wet deposition monitoring stations in Western Washington and 1 in Eastern Washington (in Whitman County) (NADP 2017). In conjunction with this wet deposition modeling, EPA uses emissions and ambient concentration data to model dry deposition based on emissions and one dry deposition station in Mt. Rainier National Park (now discontinued) (EPA 2015, EPA 2016).

WSDA reviewed similar studies to assess what, if any, atmospheric deposition information was available from other agricultural areas on the west coast. A significant nitrogen loading study by the University of California at Davis (Viers et al. 2012) includes atmospheric deposition data for California's Central Valley. EPA modeling in the Tulare Lake Basin and Salinas Valley was reviewed for that study to identify atmospheric deposition levels of 9 and 5 lb N/ac-yr, respectively. These numbers greatly exceed atmospheric deposition estimates for this study area. There are a few reasons why the levels seen in the Tulare Lake Basin and the Salinas Valley are not comparable to those estimated in Yakima. The first major difference between the regions is proximity to major urban areas; a significant source of deposition in California's Central Valley is the San Francisco Bay area transportation corridor. The Yakima Valley does not have a transportation or population hub of similar magnitude and proximity. In addition, the scale of animal agriculture in the Central Valley is an order of magnitude greater than that found in Yakima County (approximately 640 dairies compared to about 50 in the GWMA). Finally, the numbers in the Tulare Lake Basin and Salinas Valley are likely higher due to the effect of the Sierra Nevada – winds travelling from heavily populated areas meet the Sierra Nevada and deposit atmospheric pollutants in the adjacent valleys (Viers et al. 2012). Again, this is not a scenario seen in the Yakima Valley where winds travel mostly away from the mountains towards the Columbia River Basin. It is not surprising that the nitrogen deposition estimates from would be much higher in the UC Davis study than in the Lower Yakima Valley GWMA.

## Methods, Limitations, and Assumptions

### *Limitations*

The lower Yakima Valley has low annual rainfall (6.8 inches) and moderate winter snowfall (12.4 inches per year), from mean yearly records kept from 1894 – 2012 at Sunnyside, WA (Western Regional Climate Center 2017). As mentioned above, Washington State has 5 wet deposition monitoring stations in the National Atmospheric Deposition Program but only 1 located on the eastern side of the Cascade Mountains (NADP 2017). One limitation of this study is the very small amount of deposition data collected in the study area. The location of the eastern Washington NADP station (in Whitman County, NADP 2017) is similar in precipitation but not in geography or land use practice (Whitman County produces dryland crops such as wheat, barley, and dry peas) (WSDA 2016). There is also a limited amount of development and only small transportation corridors located in Whitman County, as compared to our study area in the lower Yakima Valley, surrounded by mountains, reasonably sized cities and towns, and bisected by a major interstate. In addition, the Yakima Valley is largely planted in irrigated cropland and a large number of concentrated animal feeding operations (none of which are found in Whitman County) (WSDA 2016). Use of the wet deposition data from the Whitman County station would likely underestimate the influence of atmospheric deposition on the geographic footprint of the lower Yakima Groundwater Management Area. This limitation makes it more difficult to use Washington measurements in the analysis.

Another limitation of this estimate is categorization of ecosystems and development types that may result in deposited atmospheric nitrogen available for transport to groundwater. It is expected that in most urban areas (with a high percentage of impervious surface), any atmospheric deposition would likely be retained in the natural ecosystem through turfgrass sequestration or make its way to surface water via stormwater runoff. Natural areas are often nitrogen limited and atmospheric deposition in those regions may be used in the production of increased biomass and not available for leaching (Viers et al. 2012). It is assumed that atmospheric deposition does not contribute significantly to groundwater loading in these systems. However, this study does not include a refined analysis to exclude these areas.

### *Methods*

The mechanism for nitrogen loading through atmospheric deposition to cropland is mobilization to groundwater through irrigation; atmospheric deposition to cropland is included as an input in the mass balance conducted in Section 2. IRRIGATED AGRICULTURE. As a result, this section of the report excludes the acreage from the irrigated agriculture section. In addition, the known areas of pens and lagoons are excluded (both of these estimates already account for atmospheric nitrogen deposition).

In order to establish low, medium, and high estimated available nitrogen due to atmospheric deposition, WSDA relied on 2 main sources; a state atmospheric scientist with the Washington State Department of Ecology (Dr. Ranil Dhammapala<sup>4</sup>) and the data available for wet and dry deposition from the NADP-managed Mt. Rainier station.

---

<sup>4</sup> Medium and high deposition values were recommended by Dr. Dhammapala during a meeting on November 3, 2016.

The lowest number used is the combination of the most recently available annual wet and dry deposition data from the NADP Mt. Rainier station. Deposition reported includes dry nitric acid, dry ammonium, dry nitrate, wet ammonium, and wet nitrate (EPA 2016). This is believed to be a good surrogate for low deposition due to the considerable transportation corridor along I-5 in western Washington mimicking farm-related emissions and deposition seen in eastern Washington.

The average estimate provided by Dr. Dhammapala takes into account modeled deposition in the lower Yakima Valley over a 5-day period during December, when stagnant air and regular inversions result in poor regional air quality. For the highest rate estimate, WSDA again relied on feedback from Dr. Dhammapala to include a multiplier of 3 times the average rate to generate an expected upper limit for atmospheric deposition.

An underlying assumption included in this analysis is that deposition within the design surface area of each lagoon is conveyed to the lagoon liquid and accounted for as lagoon nitrogen concentration in the lagoon seepage calculation.

The total area used in the final annual calculations excludes 210 acres of lagoons, 2,096 acres of dairy and non-dairy livestock pens, and 98,881 acres of irrigated agricultural land. Atmospheric deposition on these areas was incorporated into calculations elsewhere in this report. The total remaining acreage used in the calculation below is 73,976 acres (ton N/yr calculation) or 29,937.05 hectares (kg N/yr calculation).

## Results

The low, medium, and high atmospheric deposition rates are listed in the table below (Table 30).

Table 30. Low, medium, and high atmospheric deposition rates

	<b>Deposition rate (kg N/ha)</b>	<b>Deposition rate (lb N/ac)</b>
Low	1.69	1.53
Medium	2.30	2.05
High	6.89	6.15

The low rate of 1.53 lb/acre is the result of the most recently reported year (2012) of wet and dry atmospheric nitrogen deposition at the Mt. Rainier station (EPA 2016).

The medium rate, as mentioned above, is the result of a 5-day modeled average from December 2015. The final estimate of 2.05 lb/acre was provided by state atmospheric scientist Dr. Ranil Dhammapala.

The high rate multiplies the medium rate by a safety factor of 3, accounting for transient atmospheric conditions retaining local emissions in the valley when air quality is already poor. This high rate of 6.15 lb/acre is also in the range of values used in the UC Davis study of the Salinas Valley and Tulare Lake Basin (Viers et al. 2012).

## Conclusions and Recommendations

The total estimated deposition across the entire GWMA (excluding irrigated agricultural lands, animal pens and manure lagoons) is shown in Table 31.

Table 31. Estimated atmospheric nitrogen deposition in the GWMA

	<b>Total Deposition (kg N/yr)</b>	<b>Total Deposition (tons N/yr)</b>
Low	51,000	57
Medium	69,000	76
High	206,000	227

These estimates likely represent a significant overestimate of loading potential from atmospheric deposition. The number used as the rate is the amount of nitrogen deposited on the landscape, but the amount of nitrogen that subsequently is available for transport to groundwater is very different. Deposited nitrogen may be used by the ecosystem or be transported with precipitation to surface water before it leaches to groundwater. There are likely environments in the GWMA where very little or none of the deposited nitrogen reaches groundwater. A more detailed literature review and GIS analysis of regions likely and unlikely to result in leaching of deposited nitrogen to groundwater would result in a large improvement of the accuracy of this estimate. This would not have to involve additional modeling or monitoring work. However, the deposition numbers used are also estimates based on best professional judgment and evaluation of limited data. In the future, the GWAC may benefit from additional model runs and collection of local wet and dry deposition information to refine this estimate of the potential impacts of atmospheric deposition on the system.

## Conclusions and Recommendations

### Usage Example

To demonstrate how the nitrogen estimates could be used, an example area was examined in detail (Figure 12). An area with a 3-mile radius was assessed with the high rate nitrogen estimates for agricultural activities (irrigated agriculture and CAFO lagoons and pens), This area was chosen simply because it contains both a substantial acreage of irrigated agriculture as well as a number of CAFOs. This example contains 13 of the 15 crops assessed in the irrigated agricultural section. The high rate estimated available nitrogen from this region is over 2,000 ton N/year, of which 67% came from irrigated agriculture, 23% came from CAFO lagoons, and 10% came from CAFO pens.

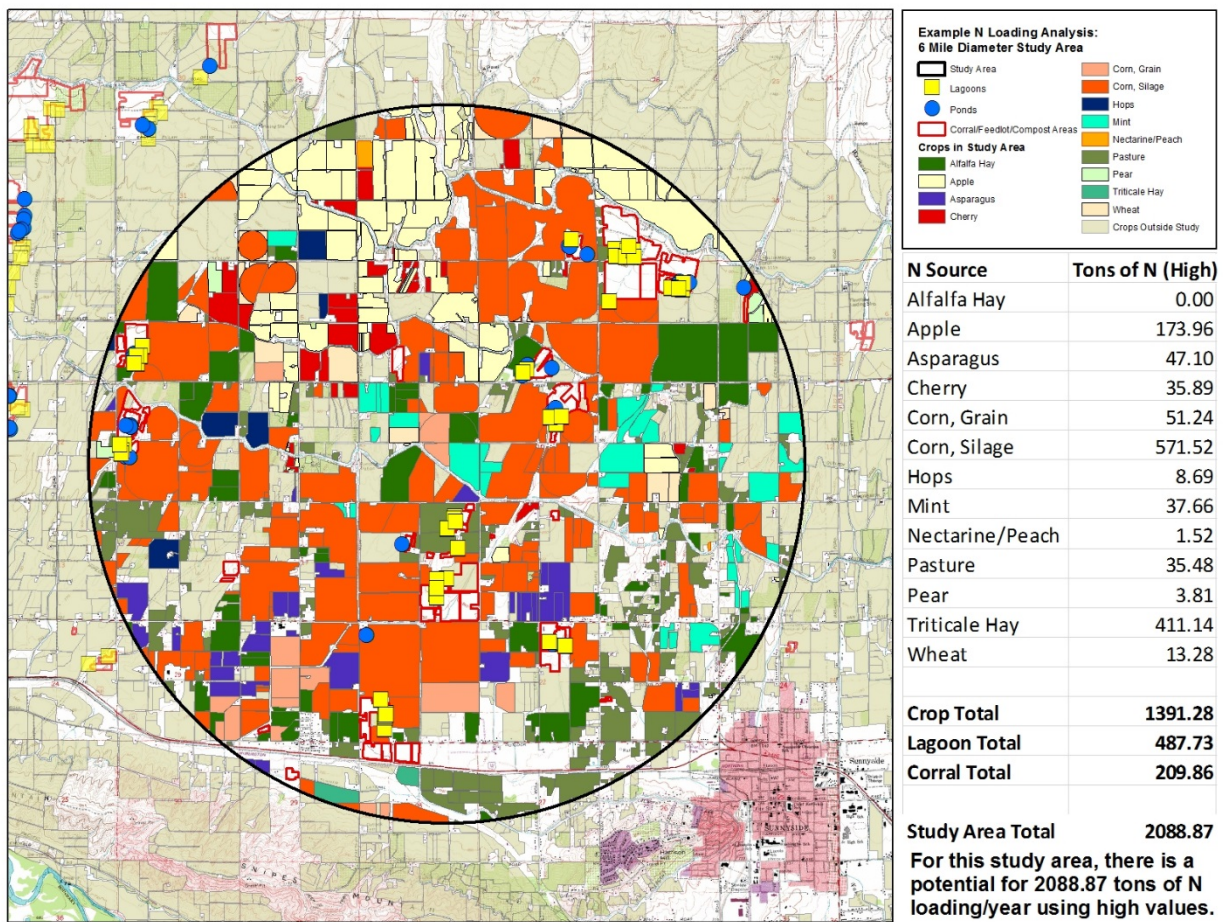

Figure 12. Example assessment of available nitrogen in ton N/year for an area located near Sunnyside, Washington

Similar to the irrigated agriculture assessment over the entire GWMA, the top 3 crops with nitrogen surpluses were silage corn, triticale, and apples. The large acreage of silage corn is shown in orange throughout the assessed area, and apple fields are shown in cream in the top part of the circle. Several fields with triticale are visible in the bottom part of the map, but most triticale on this graph is double cropped with silage corn; those fields are represented as silage corn. This example



demonstrates the importance of evaluating contributions from different nitrogen sources at an appropriate scale; different regions in the GWMA will have very different nitrogen sources.

### Conclusions

The ranges calculated (between low and high evaluation points) were very large for irrigated agriculture, lagoons, and pens (an entire order of magnitude). For RCIM sources, the ranges were much smaller. For this reason, agricultural activities (both irrigated agriculture and activities at CAFOs) should be the first candidate for additional research to narrow the range of estimated available nitrogen.

In all scenarios (low, medium, and high), evaluated over the entire acreage of the GWMA, the largest nitrogen contributors are irrigated agriculture, CAFO lagoons, and then CAFO pens. These activities account for 86, 95, and 96% of the available nitrogen in low, medium, and high scenarios, respectively (Figure 13). However, the large contribution to available nitrogen from irrigated agriculture is largely due to the high acreage of irrigated agriculture, with about 99,000 acres of irrigated land in the GWMA. The nitrogen from different land uses was also evaluated on a per-acre basis (Table 32). In this analysis, the top contributor to estimated available nitrogen at all evaluation levels was CAFO lagoons. With per-acre nitrogen losses 1-2 orders of magnitude above any other contributor, in an area with large a number of lagoons, based on these calculations, the lagoons will supply the most nitrogen. Additional top contributors on a per-acre basis vary in the low, medium, and high scenarios. In the low rate scenario, the top 3 are CAFO lagoons, ROSS, and LOSS. In the medium and high rate scenarios, the top 3 are CAFO lagoons, CAFO pens, and ROSS. This variability in per-acre available nitrogen estimates suggests that evaluating small geographic areas individually based on the activities present will be very important to identify management needs in different regions. An example of this approach was shown in Figure 12 and more work of this type could be conducted by the county.

Table 32. Estimated nitrogen available per acre from all sources at low, medium, and high range

Source		Area (acres)	Low (lb/acre-year)	Medium (lb/acre-year)	High (lb/acre-year)
Irrigated Agriculture		96,186	11	60	181
CAFO	Pens	2,096	67	480	892
	Lagoons	210	1,354	7,448	13,542
RCIM	ROSS	398	223	403	662
	LOSS	3	195	209	225
	COSS	30	163	173	183
	Residential Fertilizer	4,381	4.7	11.7	18.6
	Small Scale Farms	2,096	4.3	10.7	17.1
Atmospheric Deposition		73,976	1.53	2.05	6.15

Blue shading indicates top 3 contributors in each range (low, medium, high).

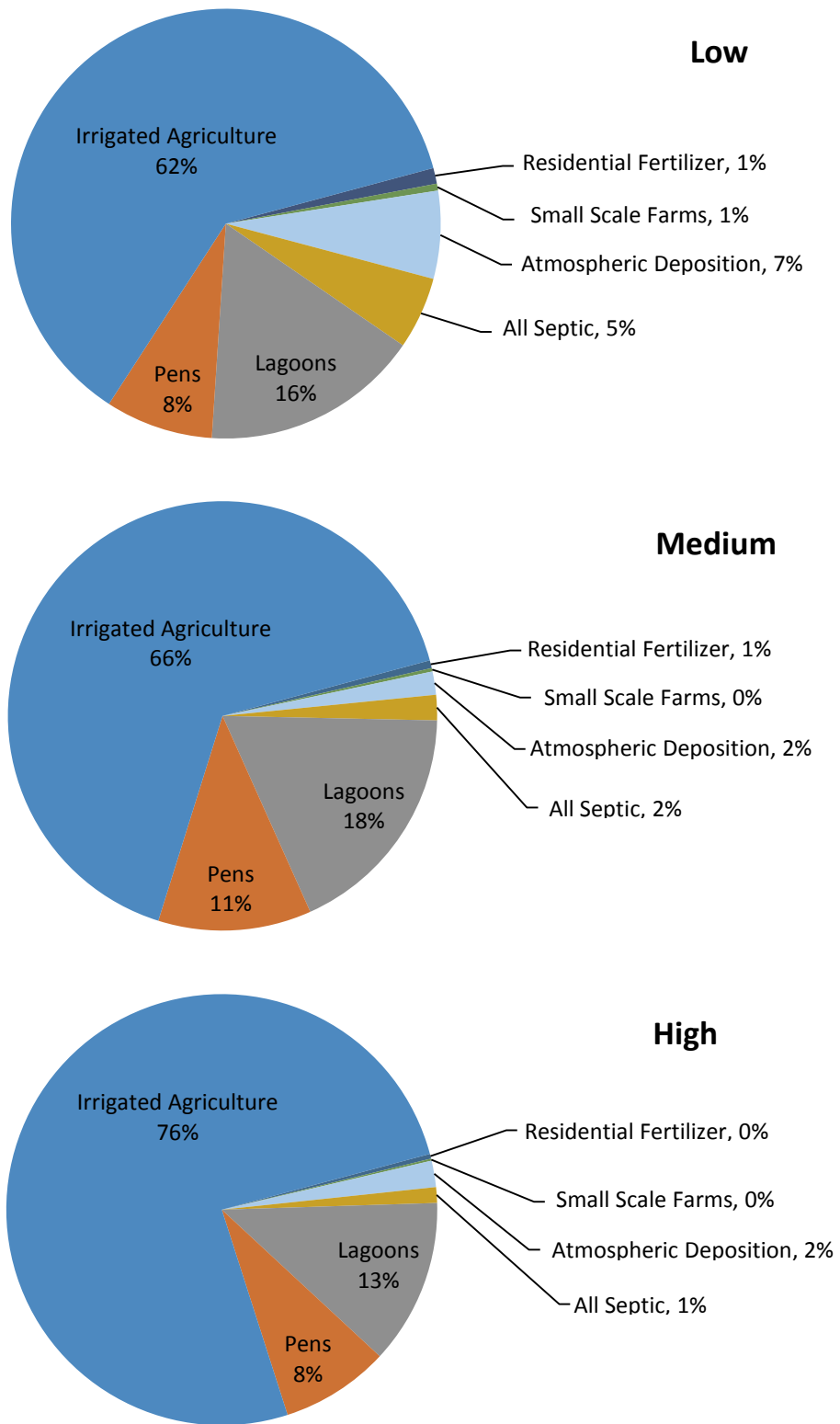

Figure 13. Low, medium, and high estimates from all sources, with percentage of total for each category

## Recommendations

WSDA has identified top priorities for improving the estimates made in this study. These items were chosen because they relate to land uses with large acreages, large estimates of available nitrogen, or they would provide calibration for modeled estimates.

- Update all calculations as and when new information becomes available (for example, if information on lagoon liner condition ratings or seepage rates becomes available, that information should be incorporated into these estimates).
- Compare irrigated agriculture mass balance predictions to the deep soil sampling results to calibrate the model.
- Conduct a statistically-based study of lagoon seepage rates in the GWMA to improve seepage estimates.
- Conduct a statistically-based study of soil nitrogen concentrations beneath pens to provide local data for pen nitrogen loss estimates.
- Conduct a statistically-based study of lagoon nitrogen concentrations to confirm lagoon nitrogen concentrations used in this study.

In addition to these recommendations, there are other steps that could be taken to improve these estimates. These additional options are lower priority because WSDA believes they are less likely to result in changes to the estimates.

- A sensitivity analysis over all inputs to identify which inputs have the largest effect on the estimates; those inputs should be the top priority for additional study.
- Categorize impoundments by primary use, and use-specific parameters could be included in the estimate (for example, main or flush lagoons vs secondary lagoons).
- Research construction dates of existing lagoons, pair with liner condition ratings and historic NRCS recommendations, and generate effective permeabilities for each lagoon.
- Conduct a statistically-based study of soil nitrogen concentrations beneath lagoons to estimate nitrogen loss rates and storage in the soil.
- Identify impoundments are used as settling basins or ponds and review construction techniques to determine whether additional analysis for settling basins is needed.
- Conduct a statistically-based study of soil beneath composting areas to provide data for compost area nitrogen loss estimates.
- Review literature on the fate of deposited nitrogen for different ecosystems and land uses; pair with GIS analysis to determine the fate of deposited nitrogen for different land uses.

During this project WSDA has also identified some critical information gaps affecting growers.

- Most Washington State University Extension fertilizer guides currently available date to the 1970's. Updating these would provide crop growers with valuable information to use in decision making.
- Synthesis of existing data and new research on several topics would also help: soil organic matter mineralization, organic fertilizer composition and breakdown rates, and the interactions and effects when fertilizers of different types (for example, manure and commercial fertilizer) are applied during the same growing season.

These study results can be used in several different ways to aid the GWAC as they choose how to allocate limited resources.

- Review contributions from all sources simultaneously, spatially throughout the GWMA, to identify areas where available nitrogen is high or where contributions from several sources overlap.
- Review nitrogen availability data in conjunction with other data layers (depth to groundwater, soil type, documented groundwater nitrogen concentrations, deep soil sampling results, proximity to drinking water supply wells, or proximity to vulnerable or marginalized communities) to identify areas with elevated risk of nitrogen moving to groundwater and areas where elevated groundwater nitrogen concentrations will be particularly harmful.

DRAFT

## References

- Beale P, Baker R. 2009. Quality Assurance Project Plan: WSDA Agricultural Land Use.
- Campbell Mathews M, Frate C, Harter T, Sather S. 2001. Lagoon Water Composition, Sampling and Field Analysis. In: Proceedings 2001 California Plant and Soil Conference. Vol. 1. Fresno, CA.
- [Census] United States Census Bureau. 15 Jan 2017. Population estimates, April 1, 2010 (V2016). [accessed Jan Mar 2017]. <https://www.census.gov/quickfacts/table/>
- [Commerce] Department of Commerce (US), Bureau of the Census. 1927. United States Census of Agriculture: 1925. Part III. Washington, DC: U.S. Government Printing Office.
- [Commerce] Department of Commerce (US), Bureau of the Census. 1932. Fifteenth Census of the United States: 1930. Agriculture, Volume II, Part 3 - The Western States. Washington, DC: U.S. Government Printing Office.
- [Commerce] Department of Commerce (US), Bureau of the Census. 1936. United States Census of Agriculture: 1935. Reports for States with Statistics for Counties and a Summary for the United States. Washington, DC: U.S. Government Printing Office.
- [Commerce] Department of Commerce (US), Bureau of the Census. 1942. Sixteenth Census of the United States: 1940. Agriculture, Volume 1, Statistics for Counties, Part 6. Washington, DC: U.S. Government Printing Office.
- [Commerce] Department of Commerce (US), Bureau of the Census. 1946. United States Census of Agriculture: 1945. Volume 1, Statistics for Counties, Part 32 Washington and Oregon. Washington, DC: U.S. Government Printing Office.
- [Commerce] Department of Commerce (US), Bureau of the Census. 1952. U.S. Census of Agriculture: 1950. Vol. 1, Counties and State Economic Areas, Part 32 Washington and Oregon. Washington, DC: U.S. Government Printing Office.
- [Commerce] Department of Commerce (US), Bureau of the Census. 1956. U.S. Census of Agriculture: 1954. Vol. 1, Counties and State Economic Areas, Part 32 Washington and Oregon. Washington, DC: U.S. Government Printing Office.
- [Commerce] Department of Commerce (US), Bureau of the Census. 1961. U.S. Census of Agriculture: 1959. Vol. 1, Counties, Part 46 Washington. Washington, DC: U.S. Government Printing Office.
- [Commerce] Department of Commerce (US), Bureau of the Census. 1967. 1964 United States Census of Agriculture: Volume 1 Part 46. WASHINGTON. Washington, DC: U.S. Government Printing Office.
- [Commerce] Department of Commerce (US), Bureau of the Census. 1972. 1969 Census of Agriculture: Volume 1. Area reports, Part 46. WASHINGTON. Washington, DC: U.S. Government Printing Office.
- [Commerce] Department of Commerce (US), Bureau of the Census. 1977. 1974 Census of Agriculture: Volume 1, Part 47. Washington State and County Data. Washington, DC: U.S. Government Printing Office.
- [Commerce] Department of Commerce (US), Bureau of the Census. 1981. 1978 Census of Agriculture: Volume 1. State and County Data, Part 47. Washington. Washington, DC: U.S. Government Printing Office, AC78-A-47.

- [Commerce] Department of Commerce (US), Bureau of the Census. 1984. 1982 Census of Agriculture: Volume 1. Geographic Area Series, Part 47. Washington State and County Data. Washington, DC: U.S. Government Printing Office, AC82-A-47.
- [Commerce] Department of Commerce (US), Social and Economic Statistics Administration, Bureau of the Census. 1989. 1987 Census of Agriculture: Volume 1. Geographic Area Series, Part 47. Washington State and County Data. Washington, DC: U.S. Government Printing Office, AC87-A-47.
- [Commerce] Department of Commerce (US), Social and Economic Statistics Administration, Bureau of the Census. 1994. 1992 Census of Agriculture: Volume 1. Geographic Area Series, Part 47. Washington State and County Data. Washington, DC: US Bureau of the Census, AC92-A-47.
- Dairy Nutrient Management. Chapter 90.64 RCW (1998).
- [Ecology] Washington State Department of Ecology, Washington State Department of Agriculture, Washington State Department of Health, The Yakima County Public Works Department, Environmental Protection Agency (US). 2010. Lower Yakima Valley Groundwater Quality: Preliminary Assessment and Recommendations Document. Olympia, WA: Washington State Department of Ecology. Publication No. 10-10-009.
- [ESD] Washington State Employment Security Department. 2015. Labor Market and Performance Analysis, 2013 Agricultural Workforce, May 2015.
- [EPA] Environmental Protection Agency (US), Office of Research and Development, Center for Environmental Research Information, Environmental Protection Agency (US), Office of Water, Office of Wastewater Enforcement and Compliance. 1992. Wastewater Treatment/Disposal for Small Communities. Cincinnati, OH, Washington, DC: Environmental Protection Agency (US). EPA/625/R-92/005.
- [EPA] Environmental Protection Agency (US), Office of Research and Development. 1994. Guide to Septage Treatment and Disposal. Washington, DC: Environmental Protection Agency (US). EPA/625/R-94/002.
- [EPA] Environmental Protection Agency (US), Office of Water. 2002a. Onsite Wastewater Treatment Systems manual. Washington, DC: Environmental Protection Agency (US). EPA/625/R-00/008.
- [EPA] Environmental Protection Agency (US), Office of Water. 2002b. A Homeowner's Guide to Septic Systems. Washington, DC: Environmental Protection Agency (US). EPA-832-B-02-005.
- [EPA] Environmental Protection Agency (US), Region 10. 2013a. Relation between nitrate in water wells and potential sources in the lower Yakima Valley, Washington. Seattle, WA: Environmental Protection Agency (US). EPA-910-R-13-004.
- [EPA] Environmental Protection Agency (US), Region 10. 2013b. Proceeding under Section 1431(a) of the Safe Drinking Water Act, 42 U.S.C. § 300i(a). SDWA-10-2013-0080.
- [EPA] Environmental Protection Agency (US), Department of the Interior (US), National Park Service. 2015. Clean Air Status and Trends Network (CASTNET).
- [EPA] Environmental Protection Agency (US), Office of Air and Radiation. 8 Sep 2016. Mount Rainier NP (MOR409). [accessed 12 Jan 2017]. [https://www3.epa.gov/castnet/site\\_pages/MOR409.html](https://www3.epa.gov/castnet/site_pages/MOR409.html)
- Fenn ME, Haeuber R, Tonnesen GS, Baron JS, Grossman-Clarke S, Hope D, Jaffe DA, Copeland S, Geiser L, Rueth HM, Sickman, JO. 2003. Nitrogen emissions, deposition, and monitoring in the western United States. *BioScience* 53:391-403.

- Ham JM. 2002. Seepage losses from animal waste lagoons: A summary of a four-year investigation in Kansas. *Transactions of the ASAE* 45:983–992.
- Harter T, Davis H, Mathews MC, Meter RD. 2002. Shallow groundwater quality on dairy farms with irrigated forage crops. *Journal of Contaminant Hydrology* 55:287–315.
- Harter T, Kourakos G, Lockhart K. 2014. Assessing potential impacts of livestock management on groundwater. Durham, NC: Duke University. NI R 14-05 Supplemental Paper 2.
- Koenig RT, Horneck D, Platt T, Petersen P, Stevens R, Fransen S, Brown B. 2009. Nutrient management guide for dryland and irrigated alfalfa in the inland Northwest. Pacific Northwest Extension. PNW0611.
- Large On-Site Sewage System Regulations. Chapter 246-272B WAC (2011).
- Massey University. Fertilizer & Lime Research Centre - Home. [accessed 12 Jan 2017]. [http://www.massey.ac.nz/~flrc/shortcourses/SNM\\_information.html](http://www.massey.ac.nz/~flrc/shortcourses/SNM_information.html)
- Mielke LN, Swanson NP, McCalla TM. 1974. Soil profile conditions of cattle feedlots. *Journal of Environmental Quality* 3:14–17.
- Miller JJ, Curtis T, Larney FJ, McAllister TA, Olson BM. 2008. Physical and Chemical Properties of Feedlot Pen Surfaces Located on Moderately Coarse- and Moderately Fine-Textured Soils in Southern Alberta. *Journal of Environmental Quality* 37:1589–1598.
- [NADP] National Atmospheric Deposition Program National Trends Network. 2017 Jan 12. NTN Site Information. National Atmospheric Deposition Program. [accessed 12 Jan 2017]. <http://nadp.sws.uiuc.edu/data/sites/list/?net=NTN>
- [OFM] Washington State Office of Financial Management, Forecasting Division, Department of Commerce (US), US Census Bureau. 2010. OFM 2000-2013 SAEP Population and Housing Estimates for 2010 Census Block Groups.
- On-Site Sewage Systems. Chapter 246-272A WAC (2005).
- Pettygrove GS, Heinrich AL, Eagle AJ. 2010. Manure Technical Guide Series, University of California Cooperative Extension: Dairy manure nutrient content and forms.
- Potter SR, Andrews S, Atwood JD, Kellogg RL, Lemunyon J, Norfleet L, Oman D. 2006. Model Simulation of Soil Loss, Nutrient Loss, and Change in Soil Organic Carbon Associated with Crop Production. United States Department of Agriculture, Natural Resources Conservation Service, Conservation Assessment Effects Project.
- [USDA NASS] United States Department of Agriculture, National Agricultural Statistics Service. 1999. 1997 Census of Agriculture: Volume 1. Geographic Area Series. Part 47. Washington State and County Data. Washington, DC: United States Department of Agriculture, National Agricultural Statistics Service, AC97-A-47.
- [USDA NASS] United States Department of Agriculture, National Agricultural Statistics Service. 2004. 2002 Census of Agriculture: Volume 1. Geographic Area Series. Part 47. Washington State and County Data. Washington, DC: United States Department of Agriculture, National Agricultural Statistics Service, AC-02-A-47.
- [USDA NASS] United States Department of Agriculture, National Agricultural Statistics Service. 2009. 2007 Census of Agriculture: Volume 1. Geographic Area Series. Part 47. Washington State and County Data. Washington, DC: United States Department of Agriculture, National Agricultural Statistics Service, AC-07-A-47.

- [USDA NASS] United States Department of Agriculture, National Agricultural Statistics Service. 2014. 2012 Census of Agriculture: Volume 1. Geographic Area Series. Part 47. Washington State and County Data. Washington, DC: United States Department of Agriculture, National Agricultural Statistics Service, AC-12-A-47.
- [USDA NRCS] United States Department of Agriculture, Natural Resources Conservation Service. 2009. Chapter 10. Agricultural Waste Management System Component Design. In: Title 210. National Engineering Handbook. Part 651. Agricultural Waste Management Field Handbook.
- [USDA NRCS] United States Department of Agriculture, Natural Resources Conservation Service. 2013. NRCS Assessment Procedure for Existing Waste Storage Ponds (WSP). Spokane, WA. Engineering #23.
- [USDA NRCS] United States Department of Agriculture, Natural Resources Conservation Service, Soil Survey Staff. 2014. Soil Survey Geographic (SSURGO) Database.
- [USDA NRCS] United States Department of Agriculture, Natural Resources Conservation Service. 2016a. Conservation Practice Standard: Pond Sealing or Lining - Compacted Soil Treatment: Code 520. United States Department of Agriculture, Natural Resources Conservation Service.
- [USDA NRCS] United States Department of Agriculture, Natural Resources Conservation Service. 2016b. Conservation Practice Standard: Waste Storage Facility: Code 313. United States Department of Agriculture, Natural Resources Conservation Service.
- [USGS] United States Geological Survey. 2012. Water-resources data for the United States, Water Year 2012: US Geological Survey Water-Data Report WDR-US-2012, site 12510500.
- Vaccaro JJ, Jones MA, Ely DM, Keys ME, Olsen TD, Welch WB, Cox SE. 2009. Hydrogeologic Framework of the Yakima River Basin Aquifer System, Washington. Reston, VA: US Department of the Interior, US Geological Survey. Scientific Investigations Report 2009-5152.
- Vaillant GC, Pierzynski GM, Ham JM, DeRouchey J. 2009. Nutrient accumulation below cattle feedlot pens in Kansas. *Journal of Environmental Quality* 38:909–918.
- van der Schans ML, Harter T, Leijnse A, Mathews MC, Meyer RD. 2009. Characterizing sources of nitrate leaching from an irrigated dairy farm in Merced County, California. *Journal of Contaminant Hydrology* 110:9–21.
- Viers JA, Liptzin D, Rosenstock TS, Jensen VB, Hollander AD, McNally A, King AM, Kourakos G, Lopez EM, De La Mora N, et al. 2012. Nitrate Sources and Loading to Groundwater. Technical Report 2 in: Addressing nitrate in California's drinking water with a focus on Tulare Lake Basin and Salinas Valley Groundwater. Report for the State Water Resources Control Board Report to the Legislature. Davis, CA: Institute for Watershed Sciences, University of California, Davis.
- Water Quality Data Act. Chapter 90.48.570-90.48-590 RCW (2004).
- [WRCC] Western Regional Climate Center. 2012 Oct 31. SUNNYSIDE, WASHINGTON - Period of Record General Climate Summary - Precipitation. [accessed 17 Jan 2017]. <http://www.wrcc.dri.edu/cgi-bin/cliMAIN.pl?wa8207>
- [WSDA] Washington State Department of Agriculture. 2015. 2014 Agricultural Land Use Information.
- [WSDA] Washington State Department of Agriculture. 2016. 2015 Agricultural Land Use Information.



## Appendix A: Data Sources, Uses, and Potential Concerns

Section	Data	Source	Use	Concerns
CAFO: Pens and compost areas	Pen locations and dimensions	2014 dairy registration locations USDA National Agricultural Imagery Program 2013, 2015 imagery	Pen calculation	Potential for human error. Changes in operation since data collection.
CAFO: Pens and compost areas	Pen location QA	WSDA NRAS QA procedure (Beale and Baker 2009)	Pen calculation	Entire data set not ground truthed.
CAFO: Pens and compost areas	Dairy CAFO pens	NAIP 2013, 2015 imagery WSDA DNMP WSDA Animal Services	Pen calculation	Potential for human error. Changes in operation since data collection.
CAFO: Pens and compost areas	Non-Dairy CAFO pens	NAIP 2013, 2015 imagery WSDA DNMP WSDA Animal Services	Pen calculation	Potential for human error. Changes in operation since data collection.
CAFO: Pens and compost areas	Compost locations	NAIP 2013, 2015 imagery 2014 dairy registration locations	Pen calculation	Potential for human error. Changes in operation since data collection. Potential misidentification of silage storage as compost area.
CAFO: Pens and compost areas	High rate for pens	Viers et al. 2012	Pen calculation	Data is not specific to Yakima Valley. Research conducted in California's San Joaquin Valley and in Kansas where meteorological conditions are very different from Yakima.
CAFO: Pens and compost areas	Low rate for pens	Viers et al. 2012	Pen calculation	Data is not specific to Yakima Valley. Research conducted in California's Tulare Lake Basin where meteorological conditions are similar to Yakima.

Section	Data	Source	Use	Concerns
CAFO: Lagoons	All lagoon locations	WSDA DNMP staff NAIP 2013, 2015 Google Earth	Lagoon calculation	Potential for human error. Potential misidentification of irrigation pond or settling pond as lagoon and vice versa.
CAFO: Lagoons	Lagoon location QA	WSDA NRAS QA procedure (Beale and Baker 2009)	Lagoon calculation	Entire data set not ground truthed.
CAFO: Lagoons	Lagoon capacity	DNMP lagoon assessment project	Lagoon calculation	Provides an average snapshot in time. Lagoon capacity varies throughout year.
CAFO: Lagoons	Length and width of lagoons	Nutrient management plans DNMP staff onsite data collection using ArcGIS Collector	Lagoon calculation	Potential for human error.
CAFO: Lagoons	Individual lagoon design depth	DNMP lagoon assessment Average from DNMP lagoon assessment	Lagoon calculation	All lagoons do not have recorded design depth.
CAFO: Lagoons	Lagoon total nitrogen concentration	EPA 2013a Self-reported data to SYCD	Lagoon calculation	Potential bias in both sources. EPA data set: small sample size, not statistically selected. SYCD data set: voluntarily self-reported, not statistically selected.
CAFO: Lagoons	Lagoon liner permeability and thickness	USDA NRCS 2009, USDA NRCS 2016a, USDA NRCS 2016b	Lagoon calculation	Unknown what percentage of lagoons were constructed to NRCS standards. Permeability and liner thickness chosen may not accurately represent range of lagoon construction.
Irrigated Agriculture	Acreage of crops in GWMA	WSDA crop mapping	Irrigated agriculture mass balance	Potential for human error.
Irrigated Agriculture	Fertilizer application data	Telephone survey	Irrigated agriculture mass balance	Potential bias from self-reported data, only a subset of each commodity represented in data.
Irrigated Agriculture	Atmospheric Deposition	Dr Ranil Dhammapala EPA 2016	Irrigated agriculture mass balance	Few deposition monitoring stations: may not accurately reflect deposition in GWMA

Section	Data	Source	Use	Concerns
Irrigated Agriculture	Irrigation water nitrogen concentration	Lower Yakima River nitrogen levels at USGS Yakima River station at Kiona (USGS 2012)  Washington State Irrigation Guide precipitation data	Irrigated agriculture mass balance	Located downstream of irrigation districts serving the GWMA. Does not account for potential increase in nitrogen concentration if water is used by successive growers.
Irrigated Agriculture	Crop residue left in fields and incorporated	Irrigated Agriculture Work Group "Estimated Nitrogen Usage for Agricultural Production in the GWMA"	Irrigated agriculture mass balance	Potential bias from IAWG.
Irrigated Agriculture	Crop uptake	Irrigated Agriculture Work Group "Estimated Nitrogen Usage for Agricultural Production in the GWMA"	Irrigated agriculture mass balance	Potential bias from IAWG.
Irrigated Agriculture	Nitrogen loss to atmosphere	Potter et al. 2009	Irrigated agriculture mass balance	
Irrigated Agriculture	Soil organic matter conversion to nitrate-nitrogen	Virginia Prest, WSDA DNMP SYCS deep soil sampling 2015 results	Irrigated agriculture mass balance	Changing assumptions based on new information; not yet established science.
RCIM	Number of households and number of people per household	Census 2010	Residential on-site sewage system calculation	Information is outdated.
RCIM	Soil type, soil classification, infiltration rate	USDA NRCS 2014	Residential on-site sewage system calculation	
RCIM	Total nitrogen per person per day	EPA 2002a	Residential on-site sewage system calculation	

Section	Data	Source	Use	Concerns
RCIM	Denitrification in septic	EPA 2002a	Residential on-site sewage system calculation	
RCIM	Total nitrogen content of septage	EPA 1994	Residential on-site sewage system calculation	
RCIM	Average size of septic tank	WAC 246-272A-0232 (On-site...2005)	Residential on-site sewage system calculation	Actual sizes of septic tanks are unknown, the assumption that each tank meets or is equal to the minimum requirement may not be valid.
RCIM	Septic tank pumping frequency	GWMA Survey "Well Assessment Survey" EPA 2002b	Residential on-site sewage system calculation	Survey of GWMA residents is voluntary and not necessarily geographically dispersed.
RCIM	Number of migrant workers	USDA NASS 2014 Prorated total Yakima County number by crop acres within GWMA ESD 2015	Residential on-site sewage system calculation	Proration of migrant workers by crop acres may not be valid, some crops require migrant workers and others do not.
RCIM	Design capacity, location, and times of use for LOSS	Washington Department of Health GIS Department	Large on-site septic system calculation	
RCIM	Average loading generated by toilet flushing	EPA 1992	Large on-site septic system calculation	Value may be outdated considering new technology.
RCIM	Design flow for LOSS	WAC 246-272B 06450(4) (b) (Large...2011)	Large on-site septic system calculation	No actual measurements of flow from LOSS system.
RCIM	Locations of COSS	WSDA DNMP number of CAFOs in GWMA	Commercial on-site septic systems calculation	Assumes all COSS are on CAFOs and that every CAFO has a COSS.

<b>Section</b>	<b>Data</b>	<b>Source</b>	<b>Use</b>	<b>Concerns</b>
RCIM	Number of employees using COSS	Reed 2004	Commercial on-site septic systems calculation	Assumes COSS at CAFOs in Yakima Valley will be the same as those in California.
RCIM	Area of maintained lawn areas	ArcMap Spatial Analysis by Yakima County	Residential lawn fertilizer calculation	Tool may misidentify some areas as lawn and miss other areas.
RCIM	Lawn fertilization frequency and rate	Scott's Turf Builder	Residential lawn fertilizer calculation	Assumes proportion of residents who fertilize Assumes that residents who fertilize follow fertilizer guidelines.
RCIM	Number of hobby farms	ArcGIS model developed by Yakima County	Small-scale commercial and hobby farms calculation	Potential for model error.
RCIM	Fertilizer application for hobby farms	RCIM Work Group	Small-scale commercial and hobby farms calculation	Potential bias in data from RCIM workgroup.
Atmospheric Deposition	Atmospheric Deposition	Dr Ranil Dhammapala EPA 2016	Atmospheric deposition estimates over GWMA	Few deposition monitoring stations: may not accurately reflect deposition in GWMA

## Appendix B: Lagoon Nitrogen Concentration Statistical Analysis

Descriptive statistics were calculated for the two datasets for comparison purposes; a summary of these statistics is displayed in Table 33. With the exception of the maximum, standard deviation, and sample size all values in the EPA data set were higher than those in the SYCD data.

Table 33. Comparison of EPA and SYCD lagoon N concentration (mg N/L)

	EPA	SYCD	Combined
Sample Size	15	23	38
Minimum	290	180	180
Q1	1000	355	455
Median	1400	768	1028
Mean	1212	949	1054
Mode	1200	336	1200
Q3	1600	1092	1401
Maximum	1800	3633	3632
Standard Deviation	492	802	702

Figure 14 displays the data from both sources on one boxplot. Two measurements in the SYCD data set are classified as outliers because they exceed 1.5 times the interquartile range (the difference between the 1<sup>st</sup> and 3<sup>rd</sup> quartile). These measurements are displayed as small circles in the figure.

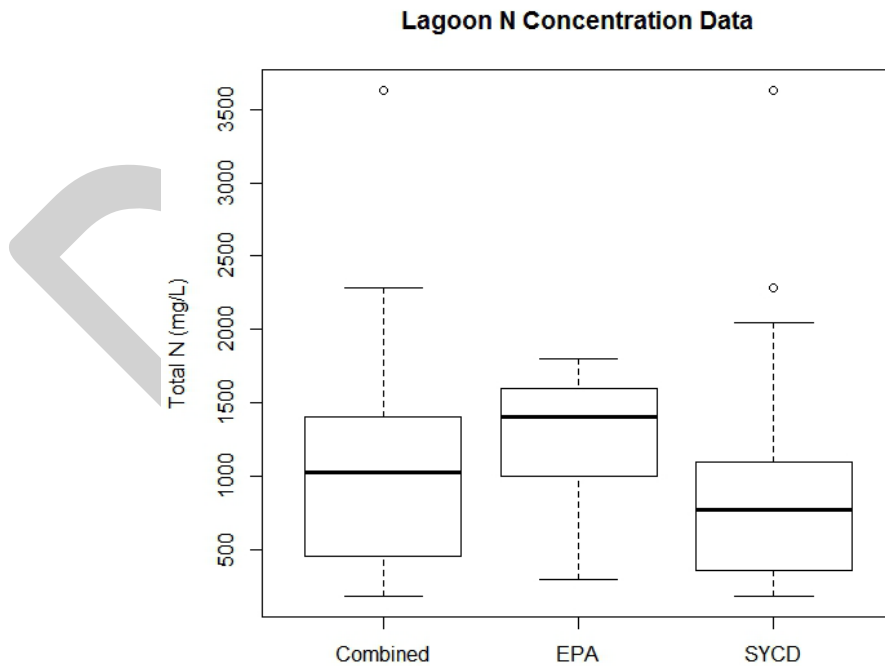

Figure 14. Boxplots of EPA and SYCD lagoon N concentration data

## Appendix C: Lagoon Surface Area Reduction Methodology

Manure storage lagoons are constructed with sloping interior and exterior sides. As a result, a change in the liquid level within the lagoon changes the liquid surface area. Since liquid surface area was used as an input in the Darcy's law calculations in the CAFO section, it was necessary to calculate the needed adjustment to surface area based on the average lagoon capacity that was used to adjust the lagoon design depths. When DNMP conducted the lagoon assessment, the site information recorded was surface area, based on delineation of the lagoon perimeter, and side slope for lagoons where the liquid level was low enough to allow determination of side slope. The following diagram (Figure 15) shows a profile (side) view of a typical manure storage lagoon. In this diagram (which is not drawn to scale) the vertical dimension has been increased to show the liquid level and side slopes, which were used to adjust the surface area. The excavation depth  $H$  is used with the liquid depth  $D$  to determine what reduction in surface dimensions (length, width, and surface area) is necessary based on the side slope  $X$ . The interior side slope (often written as a proportion,  $X:1$ ) determines the amount of lateral shift ( $X$ ) for every 1-unit change in height. This determines the total reduction in a horizontal dimension; the difference between the excavation depth  $H$  and the liquid level  $D$  ( $H-D$ ) is multiplied by the horizontal translation in side slope for every 1-unit reduction in height, which would be multiplied by two to find the total reduction in one horizontal dimension (length or width):

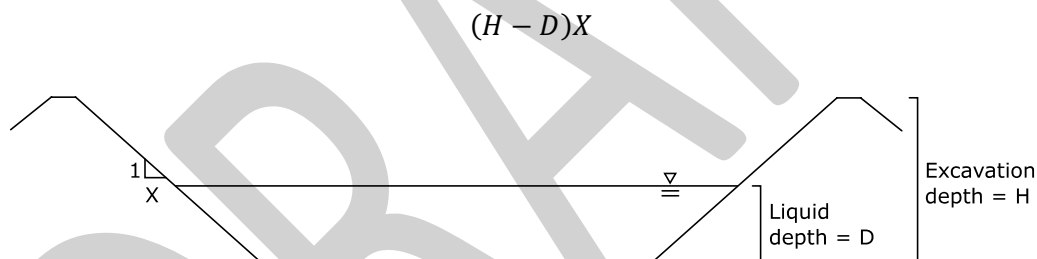

Figure 15. Profile view of typical manure storage lagoon construction. Not drawn to scale; the vertical scale on this diagram is exaggerated to show the side slopes and liquid level clearly.

This surface area adjustment depends on the typical liquid depth, the interior side slope, and also on the lagoon shape in plan view (from the top). Reducing the depth of a round lagoon from the full design depth to 43% of the full design depth would reduce the full surface area by a different proportion than the same reduction for a rectangular lagoon, for example. In order to estimate this surface area reduction it was necessary to generally characterize the range of lagoon shapes represented. The GIS data was informally reviewed; the vast majority of dairy lagoons had plan outlines ranging from a square to a rectangle with length equal to twice the width ( $L = 2W$ ). Other shapes represented were largely regular rectangles with proportions of length greater than twice the width (from  $L = 3W$  to  $L = 5W$ ). Less than 5 lagoons were triangular; these other shapes (long rectangles and triangles) were an estimated less than 10% of the lagoons in the study. Because of this relative uniformity in shape, surface area reductions were calculated for only two shapes: square and  $L = 2W$  rectangle. These calculations provided enough information about the trend that the surface area reduction would follow to make a conservative estimate. In order to do these

sample calculations it was necessary to determine an example depth, surface area, and side slope to work with. The values used were derived from the field measurements taken during the DNMP's lagoon assessment process. Note that numbers are reported in these examples to 4 decimal places and rounded at the end, corresponding to the method used for the actual calculations in which all digits were retained during the calculation.

Average surface area at full capacity: 70659.7289 ft<sup>2</sup> (n = 90)

Average depth at full capacity: 11.3029 ft (n = 105)

Average side slope: 3:1 (n = 99)

Average depth at reduced capacity:

$$0.4326 \times 11.3029 \text{ ft} = 4.8896 \text{ ft}$$

A typical square lagoon with these average values is used for a sample calculation. The following diagram (Figure 16) shows the parameters needed for the calculation: surface area at full capacity is used to calculate side length. Side length at full capacity is then used to calculate side length at reduced capacity, which is used to calculate surface area at reduced capacity. The percent reduction is based on the surface area at full capacity and the surface area at reduced capacity.

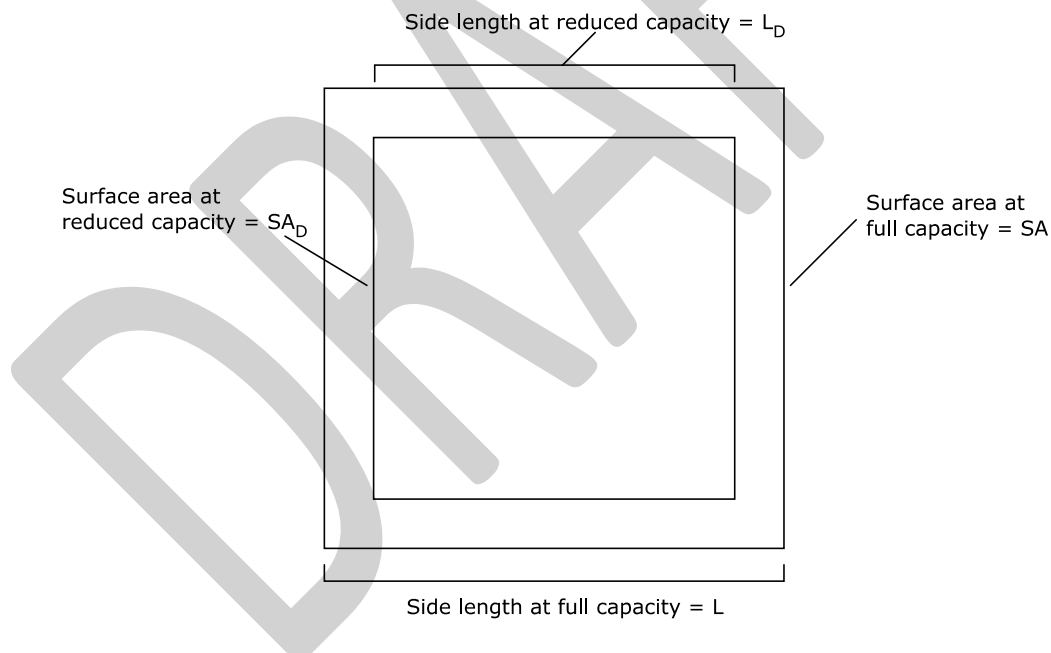

Figure 16. A typical square manure storage lagoon, with side length and surface area shown at both full and reduced capacities

$$SA = 70,659.7289 \text{ ft}^2, \text{ surface area at full capacity}$$

$$SA_D = \text{Surface area at reduced capacity, unknown}$$

$$L = \sqrt{SA} = 265.8190 \text{ ft}$$

$$L_D = L - 2(H - D) = 265.8190 \text{ ft} - 2((11.3029 \text{ ft} - 4.8896 \text{ ft})3) = 227.3395 \text{ ft}$$

$$SA_D = L_D^2 = 51,683.2623 \text{ ft}^2$$



$$\frac{SA_D}{SA} = 0.7314; 73\% \text{ reduction}$$

A typical rectangular lagoon ( $L = 2W$ ) with the same average values for surface area at full capacity, depth at full capacity, reduced depth, and side slope was used for the same calculation (Figure 17).

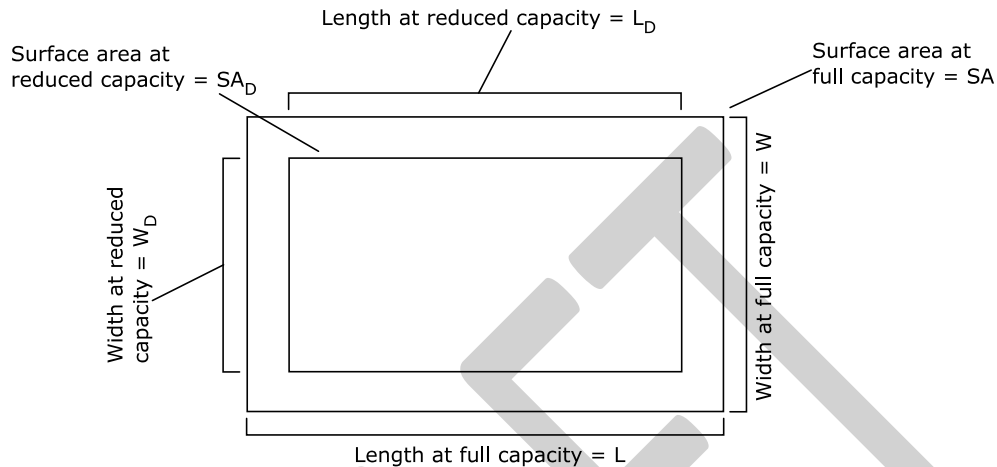

Figure 17. A typical rectangular manure storage lagoon, showing length, width, and surface area at full and reduced capacities

$$SA = 70,660 \text{ ft}^2, \text{ surface area at full capacity}$$

$$SA_D = \text{Surface area at reduced capacity, unknown}$$

$$W = \sqrt{\frac{SA}{2}} = 187.9624 \text{ ft}$$

$$L = 2 \times W = 375.9248 \text{ ft}$$

$$W_D = W - 2(H - D)X = 187.9624 \text{ ft} - 2((11.3028 \text{ ft} - 4.8896 \text{ ft})3) = 149.4830 \text{ ft}$$

$$L_D = L - 2(H - D)X = 375.9248 \text{ ft} - 2((11.3028 \text{ ft} - 4.8896 \text{ ft})3) = 337.4453 \text{ ft}$$

$$SA_D = W_D \times L_D = 50,442.3290 \text{ ft}^2$$

$$\frac{SA_D}{SA} = 0.7139; 71\% \text{ reduction}$$

Based on the preceding calculations, the surface area reduction due to the depth reduction used to adjust the depths for the Darcy's law calculation is 73% for a square lagoon and 71% for a rectangular lagoon. Additional longer, thinner rectangular lagoons would continue the same trend, with a larger surface area reduction due to the depth reduction. As a result, the 73% reduction was chosen to adjust the surface areas for Darcy's law in order to use the most conservative value available.

## Appendix D: Darcy's Law Example Calculation

Darcy's Law

$$Q = k * \frac{(H + d)}{d} * A$$

Where:

Q = the calculated volumetric flow rate (L<sup>3</sup>/T)

k = coefficient of permeability (hydraulic conductivity, either 1x10<sup>-7</sup> or 1x10<sup>-6</sup> cm/s) (L<sup>3</sup>/L<sup>2</sup>/T)

d = thickness of soil liner (estimated at 1 foot)(L)

H = vertical distance between top of liner and top of liquid storage (L)

A = lagoon area (L<sup>2</sup>)

L=length

T=time

$$N \text{ Loading} = Q * C$$

Q = volumetric flow rate calculated using Darcy's Law (L<sup>3</sup>/T)

C = Total N concentration, 1053 mg N/L

### Example Calculation

Inputs:

k= 1x10<sup>-7</sup> cm/s= 1x10<sup>-9</sup> m/s (low range hydraulic conductivity)

d= 1 ft = 0.3048 m

H= 11.3028 ft = 3.4451 m \* 0.4326 = 1.4903 m

A= 70659.7289 ft<sup>2</sup> = 6467.5036\* 0.7314 = 4801.5322 m<sup>2</sup>

C= 1052.6965 mg N/L = 10.526965x10<sup>-4</sup> kg N/L

Darcy's Law:

$$Q = 1 \times 10^{-9} \text{ m/s} * \frac{(1.4903 \text{ m} + .3048 \text{ m})}{.3048 \text{ m}} * 4801.5322 \text{ m}^2$$

$$Q = 2.8279 \times 10^5 \text{ m}^3/\text{s}$$

$$Q = 2.8279 \times 10^5 \text{ m}^3/\text{s} * \frac{86400 \text{ s}}{\text{day}} * \frac{365 \text{ day}}{\text{year}} = \mathbf{891.8085 \text{ m}^3/\text{year}}$$

Potential N Loss:

$$N \text{ Loss} = 891.8085 \text{ m}^3/\text{year} * 10.526965 \times 10^{-4} \text{ kg N/L} * \frac{1000 \text{ L}}{\text{m}^3}$$

$$N \text{ Loss} = 938.8037 \text{ kg N/year} = \mathbf{939 \text{ kg N/year}}$$

$$N \text{ Loss} = 938.8037 \text{ kg N/year} * 1 \text{ ton}/907.1848 \text{ kg} = 1.0348 \text{ tons N/year} = \mathbf{1 \text{ ton N/year}}$$

## Appendix E: Sensitivity Analysis on Darcy's Law

In order to identify which inputs to the Darcy's law calculation would have the greatest influence on the calculation's result, WSDA conducted a sensitivity analysis. Each input parameters was evaluated (keeping all other parameters constant) at a range of values Figure 18). Average parameters were used for this analysis, and then the outcome flow was evaluated for variation in each parameter individually (while the other parameters were held constant). Each parameter was evaluated for a range from 75% of the average to 125% of the average, with step sizes of 5%.

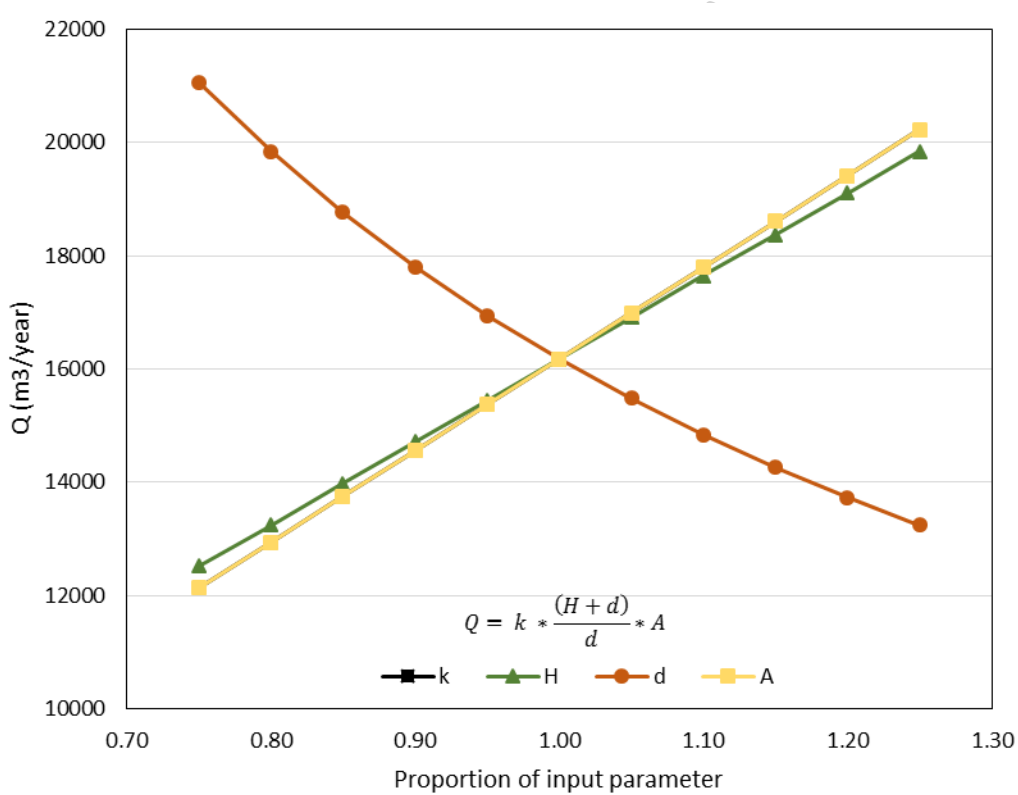

Figure 18. Results of sensitivity analysis on Darcy's law

As a result, NRAS concluded that the flow resulting from Darcy's law, calculated for an individual lagoon, is equally sensitive to all inputs. Permeability (k), surface area (A), and depth (H) are directly proportional to flow. K is invisible because it is hidden by one of the other parameters. Liner thickness (d) is inversely proportional to flow.

## Appendix F: Irrigation Water Use

Source: Jim Davenport, Stuart Turner								
	Water Duty (in/acre)	Water Duty (in/acre)	Water Duty (in/acre)	Water Duty (in/acre)	Water Duty (in/acre)	Water Duty (ac-ft/ac)	Water use (liters/ac)	Irrig water lb N/ac (based on 0.809 mg N/L, USGS 2012)
Location	Yakima	Sunnyside	Prosser	Average	Stu's #'s*	Average		
<b>Total Precip (in)</b>	7.98	6.70	7.74	7.47				
<b>Effective Precip (in)</b>	3.04	3.00	3.40	3.15				
Crop Type								
Silage Corn	28.20	29.31	28.13	28.55		2.38	2934316.238	5.23
Field Corn (Grain)	28.20	29.31	28.13	28.55		2.38	2934316.238	5.23
Triticale				28.55		2.38	2934658.872	5.23
Apple	42.42	44.37	42.42	43.07	30.00	2.50	3083704.594	5.50
Grape, Juice	26.14	27.35	26.04	26.51		2.21	2724966.959	4.86
Alfalfa Hay	35.31	37.01	35.30	35.87		2.99	3687425.426	6.58
Pasture	37.29	39.07	37.30	37.89		3.16	3894376.268	6.95
Cherry	42.94	44.94	42.92	43.60	30.00	2.50	3083704.594	5.50
Grape, Wine	26.14	27.35	26.04	26.51		2.21	2724966.959	4.86
Hops	29.52	30.76	29.39	29.89		2.49	3072397.677	5.48
Pear	39.25	41.09	39.21	39.85		3.32	4096187.602	7.31
Wheat	22.67	24.35	22.85	23.29		1.94	2393982.666	4.27
Mint	34.35	35.93	34.32	34.87		2.91	3583950.006	6.39
Asparagus**				0.00		0.00	0	0.00
Nectarine/Peach***	39.81	41.70	39.76	40.42		3.37	4155120.623	7.41

Washington State Irrigation Guide, Appendix A, Climatic Stations for Consumptive Use, WA210-VI-October 1985

\*Stu Turner best professional judgement numbers are used for water duty for apples and cherries.

\*\*No data

\*\*\*Washington State Irrigation Guide, Appendix A, Climatic Stations for Consumptive Use, WA210-VI-October 1985 (added by WSDA)

## Appendix G: Nitrogen Uptake Estimates

Source: Jim Trull, SVID, Scott Stephens

### ESTIMATE OF NITROGEN USAGE FOR AGRICULTURAL PRODUCTION IN THE GWMA

Crop	Typical Yield <sup>1</sup> /Acre	Yield (Scott) <sup>4</sup>	Nitrogen Removed in Harvested Portion of the Crop - (lbs/acre)	Removal (Scott) <sup>4</sup>	Reference <sup>3</sup>	Nitrogen Uptake in Plant in Growing Cycle (lb./acre)	Uptake (Scott) <sup>4</sup>	Estimate of Nitrogen Applied <sup>2</sup> (lbs/acre)	Range		Scott's opinion <sup>4</sup>	Yield parameters <sup>4</sup>
									Production	Application		
Silage Corn	30 tons	30	250	270	A		250-290	250	25-40	12-592	22-40	Tons at 68% moisture
Grain Corn	4-8 tons	6-6.5	186	170-190	A	214	290-325	250	2.5-8.0	90-375	5.5-8	Tons Grain weight
Triticale	8 tons	7.5-8	455	190-210	B		200-225	0-100	5.0-15	0-575	6-10	Tons at 50% moisture
Apples	20 tons	20	120	40-60	A		80-120	50-100			15-40	
Grapes, Juice	10 tons	10	125	20-40	A		80-100	80			8-16	
Alfalfa Hay	8 tons	8	448	400	A	449	480				7-11	Tons at 15% moisture
Pasture	6 tons	6	300	270	A		270+				5-7	Tons at 15% moisture
Cherries	5 tons	5-6	95	25-40	A		60-100		4-8	30-50	4-8	
Grapes, Wine	6 tons	6	100	15-30	A		50-65	83	2.5-5.0	0	4-8	
Hops	1 ton	1.25	180	150-250	A		200-300		0.3-1.5	150-175	1-1.8	
Pears	20 tons	25	85	40-60	A		80-160		20-27.5	150	18-35	
Wheat	120 bu	125	175	187	A	226	275		65-120	90-213	115-140	

Crop	Typical Yield <sup>1</sup> /Acre	Scott's opinion	Nitrogen Removed in Harvested Portion of the Crop - (lbs/acre)	Removal (Scott) See References below	Reference <sup>3</sup>	Nitrogen Uptake in Plant in Growing Cycle (lb./acre)	Uptake (Scott) See references below	Estimate of Nitrogen Applied <sup>2</sup> (lbs/acre)	Range		Scott's opinion	Yield parameters
									Production	Application		
Mint	160 lb	160	160	280	D		280-320		68-70	0-275	140-180	
Asparagus	3000 lb	3500	95	20	A		50				?	
Nectarine/Peach	15 tons	15	95	50	A		95				?	

1. SYCD and IAWG

2. Various sources

3. References: A-Western Fertilizer Handbook; B - NRCS Crop Nutrient Tool; C-SYCD; D- WSU Fertilizer Guides

4. Reference from the following resources:

International Plant Nutrition Institute (ipni.net)

USDA Crop Nutrient Tool

Potash Corp (<http://potashcorp-economics.com/>)

(wfsag.com) Potash and Phosphate Institute-Agrilience